

## AD8129/AD8130

### FEATURES

#### High Speed

AD8130: 270 MHz, 1090 V/ $\mu$ s @ G = 1

AD8129: 200 MHz, 1060 V/ $\mu$ s @ G = 10

#### High CMRR

94 dB Min, DC to 100 kHz

80 dB Min @ 2 MHz

70 dB @ 10 MHz

#### High-Input Impedance: 1 M $\Omega$ Differential

Input Common-Mode Range  $\pm$ 10.5 V

#### Low Noise

AD8130: 12.5 nV/ $\sqrt{\text{Hz}}$

AD8129: 4.5 nV/ $\sqrt{\text{Hz}}$

#### Low Distortion, 1 V p-p @ 5 MHz:

AD8130, -79 dBc Worst Harmonic @ 5 MHz

AD8129, -74 dBc Worst Harmonic @ 5 MHz

#### User-Adjustable Gain

No External Components for G = 1

Power Supply Range +4.5 V to  $\pm$ 12.6 V

#### Power-Down

### APPLICATIONS

High-Speed Differential Line Receiver

Differential-to-Single-Ended Converter

High-Speed Instrumentation Amp

Level-Shifting

### GENERAL DESCRIPTION

The AD8129 and AD8130 are designed as receivers for the transmission of high-speed signals over twisted-pair cables to work with the AD8131 or AD8132 drivers. Either can be used for analog or digital video signals and for high-speed

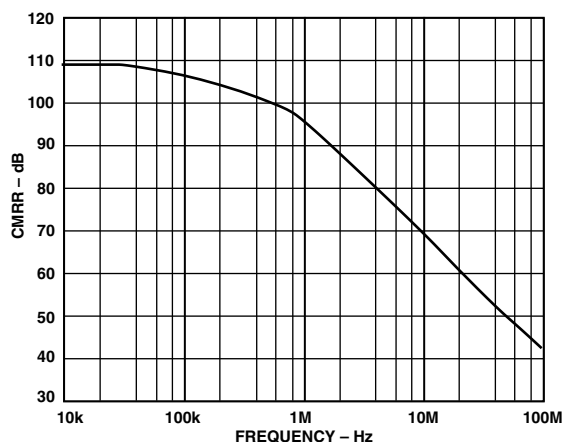

Figure 1. AD8129 CMRR vs. Frequency

REV. 0

Information furnished by Analog Devices is believed to be accurate and reliable. However, no responsibility is assumed by Analog Devices for its use, nor for any infringements of patents or other rights of third parties that may result from its use. No license is granted by implication or otherwise under any patent or patent rights of Analog Devices.

### CONNECTION DIAGRAM

(Top View)

SO-8 (R) and Micro\_SO-8 (RM)

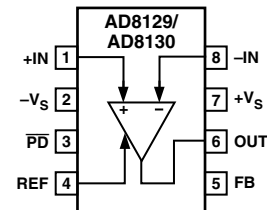

data transmission. The AD8129 and AD8130 are differential-to-single-ended amplifiers with extremely high CMRR at high frequency. Therefore, they can also be effectively used as high-speed instrumentation amps or for converting differential signals to single-ended signals.

The AD8129 is a low-noise high-gain (10 or greater) version intended for applications over very long cables where signal attenuation is significant. The AD8130 is stable at a gain of one and can be used for those applications where lower gains are required. Both have user adjustable gain to help compensate for losses in the transmission line. The gain is set by the ratio of two resistor values. The AD8129 and AD8130 have very high input impedance on both inputs regardless of the gain setting.

The AD8129 and AD8130 have excellent common-mode rejection (70 dB @ 10 MHz) allowing the use of low cost unshielded twisted-pair cables without fear of corruption by external noise sources or crosstalk.

The AD8129 and AD8130 have a wide power supply range from single 5 V supply to  $\pm$ 12 V, allowing wide common-mode and differential-mode voltage ranges while maintaining signal integrity. The wide common-mode voltage range will enable the driver receiver pair to operate without isolation transformers in many systems where the ground potential difference between drive and receive locations is many volts. The AD8129 and AD8130 have considerable cost and performance improvements over op amps and other multi-amplifier receiving solutions.

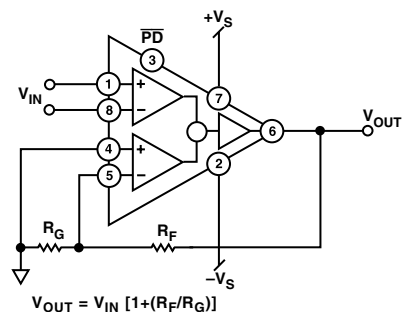

Figure 2. Typical Connection Configuration

# AD8129/AD8130—SPECIFICATIONS

**±5 V SPECIFICATIONS** (AD8129 G = 10, AD8130 G = 1,  $T_A = 25^\circ\text{C}$ ,  $V_S = \pm 5\text{ V}$ ,  $\text{REF} = 0\text{ V}$ ,  $\overline{\text{PD}} \geq V_{\text{IH}}$ ,  $R_L = 1\text{ k}\Omega$ ,  $C_L = 2\text{ pF}$ , unless otherwise noted.  $T_{\text{MIN}}$  to  $T_{\text{MAX}} = -40^\circ\text{C}$  to  $+85^\circ\text{C}$ , unless otherwise noted.)

Model Parameter	Conditions	AD8129A			AD8130A			Unit
		Min	Typ	Max	Min	Typ	Max	
<b>DYNAMIC PERFORMANCE</b>								
-3 dB Bandwidth	$V_{\text{OUT}} \leq 0.3\text{ V p-p}$ $V_{\text{OUT}} = 2\text{ V p-p}$	175	200		240	270		MHz
Bandwidth for 0.1 dB Flatness	$V_{\text{OUT}} \leq 0.3\text{ V p-p}$ , SOIC/ $\mu$ SOIC	170	190		140	155		MHz
Slew Rate	$V_{\text{OUT}} = 2\text{ V p-p}$ , 25% to 75%	925	1060		950	1090		V/ $\mu$ s
Settling Time	$V_{\text{OUT}} = 2\text{ V p-p}$ , 0.1%		20			20		ns
Rise and Fall Time	$V_{\text{OUT}} \leq 1\text{ V p-p}$ , 10% to 90%		1.7			1.4		ns
Output Overdrive Recovery			30			40		ns
<b>NOISE/DISTORTION</b>								
Second Harmonic/Third Harmonic	$V_{\text{OUT}} = 1\text{ V p-p}$ , 5 MHz		-74/-84			-79/-86		dBc
	$V_{\text{OUT}} = 2\text{ V p-p}$ , 5 MHz		-68/-74			-74/-81		dBc
	$V_{\text{OUT}} = 1\text{ V p-p}$ , 10 MHz		-67/-81			-74/-80		dBc
	$V_{\text{OUT}} = 1\text{ V p-p}$ , 10 MHz		-61/-70			-74/-76		dBc
IMD	$V_{\text{OUT}} = 2\text{ V p-p}$ , 10 MHz		-67			-70		dBc
Output IP3	$V_{\text{OUT}} = 2\text{ V p-p}$ , 10 MHz		25			26		dBm
Input Voltage Noise (RTI)	$f \geq 10\text{ kHz}$		4.5			12.5		nV/ $\sqrt{\text{Hz}}$
Input Current Noise (+IN, -IN)	$f \geq 100\text{ kHz}$		1			1		pA/ $\sqrt{\text{Hz}}$
Input Current Noise (REF, FB)	$f \geq 100\text{ kHz}$		1.4			1.4		pA/ $\sqrt{\text{Hz}}$
Differential Gain Error	AD8130, G = 2, NTSC 200 IRE, $R_L \geq 150\ \Omega$		0.3			0.13		%
Differential Phase Error	AD8130, G = 2, NTSC 200 IRE, $R_L \geq 150\ \Omega$		0.1			0.15		Degrees
<b>INPUT CHARACTERISTICS</b>								
Common-Mode Rejection Ratio	DC to 100 kHz, $V_{\text{CM}} = -3\text{ V}$ to $+3.5\text{ V}$ $V_{\text{CM}} = 1\text{ V p-p}$ @ 2 MHz	94	110		90	110		dB
	$V_{\text{CM}} = 1\text{ V p-p}$ @ 10 MHz	80	70		80	70		dB
CMRR with $V_{\text{OUT}} = 1\text{ V p-p}$	$V_{\text{CM}} = 2\text{ V p-p}$ @ 1 kHz, $V_{\text{OUT}} = \pm 0.5\text{ V dc}$		100			83		dB
Common-Mode Voltage Range	$V_{+\text{IN}} - V_{-\text{IN}} = 0\text{ V}$		$\pm 3.5$			$\pm 3.8$		V
Differential Operating Range			$\pm 0.5$			$\pm 2.5$		V
Differential Clipping Level		$\pm 0.6$	$\pm 0.75$	$\pm 0.85$	$\pm 2.3$	$\pm 2.8$	$\pm 3.3$	V
Resistance	Differential		1			6		M $\Omega$
	Common-Mode		4			4		M $\Omega$
Capacitance	Differential		3			3		pF
	Common-Mode		4			4		pF
<b>DC PERFORMANCE</b>								
Closed-Loop Gain Error	$V_{\text{OUT}} = \pm 1\text{ V}$ , $R_L \geq 150\ \Omega$ $T_{\text{MIN}}$ to $T_{\text{MAX}}$		$\pm 0.4$	$\pm 1.5$		$\pm 0.15$	$\pm 0.6$	%
Open-Loop Gain	$V_{\text{OUT}} = \pm 1\text{ V}$		20			10		ppm/ $^\circ\text{C}$
Gain Nonlinearity	$V_{\text{OUT}} = \pm 1\text{ V}$		88			74		dB
Input Offset Voltage	$V_{\text{OUT}} = \pm 1\text{ V}$ $T_{\text{MIN}}$ to $T_{\text{MAX}}$		250			200		ppm
	$T_{\text{MIN}}$ to $T_{\text{MAX}}$		0.2	0.8		0.4	1.8	mV
	$T_{\text{MIN}}$ to $T_{\text{MAX}}$		2			10		$\mu\text{V}/^\circ\text{C}$
Input Offset Voltage vs. Supply	$+V_S = +5\text{ V}$ , $-V_S = -4.5\text{ V}$ to $-5.5\text{ V}$ $-V_S = -5\text{ V}$ , $+V_S = +4.5\text{ V}$ to $+5.5\text{ V}$		-90	-84		-78	-74	mV
			-94	-86		-80	-74	dB
Input Bias Current (+IN, -IN)			$\pm 0.5$	$\pm 2$		$\pm 0.5$	$\pm 2$	$\mu\text{A}$
Input Bias Current (REF, FB)			$\pm 1$	$\pm 3.5$		$\pm 1$	$\pm 3.5$	$\mu\text{A}$
	$T_{\text{MIN}}$ to $T_{\text{MAX}}$ (+IN, -IN, REF, FB)		5			5		nA/ $^\circ\text{C}$
Input Offset Current	(+IN, -IN, REF, FB) $T_{\text{MIN}}$ to $T_{\text{MAX}}$		$\pm 0.08$	$\pm 0.4$		$\pm 0.08$	$\pm 0.4$	$\mu\text{A}$
			0.2			0.2		nA/ $^\circ\text{C}$
<b>OUTPUT PERFORMANCE</b>								
Voltage Swing	$R_{\text{LOAD}} = 150\ \Omega/1\text{ k}\Omega$	3.6/4.0			3.6/4.0			$\pm\text{V}$
Output Current			40			40		mA
Short Circuit Current	To Common		-60/+55			-60/+55		mA
	$T_{\text{MIN}}$ to $T_{\text{MAX}}$		-240			-240		$\mu\text{A}/^\circ\text{C}$
Output Impedance	$\overline{\text{PD}} \leq V_{\text{IL}}$ , In Power-Down Mode		10			10		pF
<b>POWER SUPPLY</b>								
Operating Voltage Range	Total Supply Voltage	$\pm 2.25$		$\pm 12.6$	$\pm 2.25$		$\pm 12.6$	V
Quiescent Supply Current	$T_{\text{MIN}}$ to $T_{\text{MAX}}$		10.8	11.6		10.8	11.6	mA
	$\overline{\text{PD}} \leq V_{\text{IL}}$		36			36		$\mu\text{A}/^\circ\text{C}$
	$\overline{\text{PD}} \leq V_{\text{IL}}$ , $T_{\text{MIN}}$ to $T_{\text{MAX}}$		0.68	0.85		0.68	0.85	mA
				1			1	mA
<b><math>\overline{\text{PD}}</math> PIN</b>								
$V_{\text{IH}}$			$+V_S - 1.5$		$+V_S - 1.5$			V
$V_{\text{IL}}$				$+V_S - 2.5$		$+V_S - 2.5$		V
$I_{\text{IH}}$	$\overline{\text{PD}} = \text{Min } V_{\text{IH}}$			-30				$\mu\text{A}$
$I_{\text{IL}}$	$\overline{\text{PD}} = \text{Max } V_{\text{IL}}$			-50				$\mu\text{A}$
Input Resistance	$\overline{\text{PD}} \leq +V_S - 3\text{ V}$		12.5			12.5		k $\Omega$
	$\overline{\text{PD}} \geq +V_S - 2\text{ V}$		100			100		k $\Omega$
Enable Time			0.5			0.5		$\mu\text{s}$

Specifications subject to change without notice.

# ±12 V SPECIFICATIONS

(AD8129 G = 10, AD8130 G = 1, T<sub>A</sub> = 25°C, V<sub>S</sub> = ±12 V, REF = 0 V,  $\overline{PD} \geq V_{IH}$ , R<sub>L</sub> = 1 kΩ, C<sub>L</sub> = 2 pF, unless otherwise noted. T<sub>MIN</sub> to T<sub>MAX</sub> = -40°C to +85°C, unless otherwise noted.)

Model Parameter	Conditions	AD8129A			AD8130A			Unit
		Min	Typ	Max	Min	Typ	Max	
<b>DYNAMIC PERFORMANCE</b>								
-3 dB Bandwidth	V <sub>OUT</sub> ≤ 0.3 V p-p	175	200		250	290		MHz
	V <sub>OUT</sub> = 2 V p-p	170	195		150	175		MHz
Bandwidth for 0.1 dB Flatness	V <sub>OUT</sub> ≤ 0.3 V p-p, SOIC/μSOIC		50/70			110		MHz
Slew Rate	V <sub>OUT</sub> = 2 V p-p, 25% to 75%	935	1070		960	1100		V/μs
Settling Time	V <sub>OUT</sub> = 2 V p-p, 0.1%		20			20		ns
Rise and Fall Time	V <sub>OUT</sub> ≤ 1 V p-p, 10% to 90%		1.7			1.4		ns
Output Overdrive Recovery			40			40		ns
<b>NOISE/DISTORTION</b>								
Second Harmonic/Third Harmonic	V <sub>OUT</sub> = 1 V p-p, 5 MHz		-71/-84			-79/-86		dBc
	V <sub>OUT</sub> = 2 V p-p, 5 MHz		-65/-74			-74/-81		dBc
	V <sub>OUT</sub> = 1 V p-p, 10 MHz		-65/-82			-74/-80		dBc
	V <sub>OUT</sub> = 2 V p-p, 10 MHz		-59/-70			-74/-74		dBc
	V <sub>OUT</sub> = 2 V p-p, 10 MHz		-67			-70		dBc
IMD	V <sub>OUT</sub> = 2 V p-p, 10 MHz		-67			-70		dBc
Output IP3	V <sub>OUT</sub> = 2 V p-p, 10 MHz		25			26		dBm
Input Voltage Noise (RTI)	f ≥ 10 kHz		4.6			13		nV/√Hz
Input Current Noise (+IN, -IN)	f ≥ 100 kHz		1			1		pA/√Hz
Input Current Noise (REF, FB)	f ≥ 100 kHz		1.4			1.4		pA/√Hz
Differential Gain Error	AD8130, G = 2, NTSC 200 IRE, R <sub>L</sub> ≥ 150 Ω		0.3			0.13		%
Differential Phase Error	AD8130, G = 2, NTSC 200 IRE, R <sub>L</sub> ≥ 150 Ω		0.1			0.2		Degrees
<b>INPUT CHARACTERISTICS</b>								
Common-Mode Rejection Ratio	DC to 100 kHz, V <sub>CM</sub> = ±10 V	92	105		88	105		dB
	V <sub>CM</sub> = 1 V p-p @ 2 MHz	80			80			dB
	V <sub>CM</sub> = 1 V p-p @ 10 MHz		70			70		dB
CMRR with V <sub>OUT</sub> = 1 V p-p	V <sub>CM</sub> = 4 V p-p @ 1 kHz, V <sub>OUT</sub> = ±0.5 V dc		93			80		dB
Common-Mode Voltage Range	V <sub>+IN</sub> - V <sub>-IN</sub> = 0 V		±10.3			±10.5		V
Differential Operating Range			±0.5			±2.5		V
Differential Clipping Level		±0.6	±0.75	±0.85	±2.3	±2.8	±3.3	V
Resistance	Differential		1			6		MΩ
	Common-Mode		4			4		MΩ
Capacitance	Differential		3			3		pF
	Common-Mode		4			4		pF
<b>DC PERFORMANCE</b>								
Closed-Loop Gain Error	V <sub>OUT</sub> = ±1 V, R <sub>L</sub> ≥ 150 Ω		±0.8	±1.8		±0.15	±0.6	%
	T <sub>MIN</sub> to T <sub>MAX</sub>		20			10		ppm/°C
Open-Loop Gain	V <sub>OUT</sub> = ±1 V		87			73		dB
Gain Nonlinearity	V <sub>OUT</sub> = ±1 V		250			200		ppm
Input Offset Voltage			0.2	0.8		0.4	1.8	mV
	T <sub>MIN</sub> to T <sub>MAX</sub>		2			10		μV/°C
Input Offset Voltage vs. Supply	T <sub>MIN</sub> to T <sub>MAX</sub>			1.4			3.5	mV
	+V <sub>S</sub> = +12 V, -V <sub>S</sub> = -11.0 V to -13.0 V		-88	-82		-77	-70	dB
	-V <sub>S</sub> = -12 V, +V <sub>S</sub> = +11.0 V to +13.0 V		-92	-84		-88	-70	dB
Input Bias Current (+IN, -IN)			±0.25	±2		±0.25	±2	μA
Input Bias Current (REF, FB)			±0.5	±3.5		±0.5	±3.5	μA
Input Offset Current	T <sub>MIN</sub> to T <sub>MAX</sub> (+IN, -IN, REF, FB)		2.5			2.5		nA/°C
	(+IN, -IN, REF, FB)		±0.08	±0.4		±0.08	±0.4	μA
	T <sub>MIN</sub> to T <sub>MAX</sub>		0.2			0.2		nA/°C
<b>OUTPUT PERFORMANCE</b>								
Voltage Swing	R <sub>LOAD</sub> = 700 Ω	±10.8			±10.8			V
Output Current			40			40		mA
Short Circuit Current	To Common		-60/+55			-60/+55		mA
	T <sub>MIN</sub> to T <sub>MAX</sub>		-240			-240		μA/°C
Output Impedance	$\overline{PD} \leq V_{IL}$ , In Power-Down Mode		10			10		pF
<b>POWER SUPPLY</b>								
Operating Voltage Range	Total Supply Voltage	±2.25		±12.6	±2.25		±12.6	V
	Quiescent Supply Current		13	13.9		13	13.9	mA
	T <sub>MIN</sub> to T <sub>MAX</sub>		43			43		μA/°C
	$\overline{PD} \leq V_{IL}$		0.73	0.9		0.73	0.9	mA
	$\overline{PD} \leq V_{IL}$ , T <sub>MIN</sub> to T <sub>MAX</sub>			1.1			1.1	mA
<b><math>\overline{PD}</math> PIN</b>								
V <sub>IH</sub>		+V <sub>S</sub> - 1.5			+V <sub>S</sub> - 1.5			V
V <sub>IL</sub>				+V <sub>S</sub> - 2.5			+V <sub>S</sub> - 2.5	V
I <sub>IH</sub>	$\overline{PD} = \text{Min } V_{IH}$			-30			-30	μA
I <sub>IL</sub>	$\overline{PD} = \text{Max } V_{IL}$			-50			-50	μA
Input Resistance	$\overline{PD} \leq +V_S - 3 \text{ V}$		3			3		kΩ
	$\overline{PD} \geq +V_S - 2 \text{ V}$		100			100		kΩ
Enable Time			0.5			0.5		μs

Specifications subject to change without notice.

# AD8129/AD8130—SPECIFICATIONS

**5 V SPECIFICATIONS** (AD8129 G = 10, AD8130 G = 1, T<sub>A</sub> = 25°C, +V<sub>S</sub> = 5 V, -V<sub>S</sub> = 0 V, REF = 2.5 V,  $\overline{PD} \geq V_{IH}$ , R<sub>L</sub> = 1 kΩ, C<sub>L</sub> = 2 pF unless otherwise noted. T<sub>MIN</sub> to T<sub>MAX</sub> = -40°C to +85°C, unless otherwise noted.)

Model Parameter	Conditions	AD8129A			AD8130A			Unit
		Min	Typ	Max	Min	Typ	Max	
<b>DYNAMIC PERFORMANCE</b>								
-3 dB Bandwidth	V <sub>OUT</sub> ≤ 0.3 V p-p	160	185		220	250		MHz
	V <sub>OUT</sub> = 1 V p-p	160	185		180	205		MHz
Bandwidth for 0.1 dB Flatness	V <sub>OUT</sub> ≤ 0.3 V p-p, SOIC/μSOIC		25/40			25		MHz
Slew Rate	V <sub>OUT</sub> = 2 V p-p, 25% to 75%	810	930		810	930		V/μs
Settling Time	V <sub>OUT</sub> = 2 V p-p, 0.1%		20			20		ns
Rise and Fall Time	V <sub>OUT</sub> ≤ 1 V p-p, 10% to 90%		1.8			1.5		ns
Output Overdrive Recovery			20			30		ns
<b>NOISE/DISTORTION</b>								
Second Harmonic/Third Harmonic	V <sub>OUT</sub> = 1 V p-p, 5 MHz		-68/-75			-72/-79		dBc
	V <sub>OUT</sub> = 2 V p-p, 5 MHz		-62/-64			-65/-71		dBc
	V <sub>OUT</sub> = 1 V p-p, 10 MHz		-63/-70			-60/-62		dBc
	V <sub>OUT</sub> = 2 V p-p, 10 MHz		-56/-58			-68/-68		dBc
IMD	V <sub>OUT</sub> = 2 V p-p, 10 MHz		-67			-70		dBc
Output IP3	V <sub>OUT</sub> = 2 V p-p, 10 MHz		25			26		dBm
Input Voltage Noise (RTI)	f ≥ 10 kHz		4.5			12.3		nV/√Hz
Input Current Noise (+IN, -IN)	f ≥ 100 kHz		1			1		pA/√Hz
Input Current Noise (REF, FB)	f ≥ 100 kHz		1.4			1.4		pA/√Hz
Differential Gain Error	AD8130, G = 2, NTSC 100 IRE, R <sub>L</sub> ≥ 150 Ω		0.3			0.13		%
Differential Phase Error	AD8130, G = 2, NTSC 100 IRE, R <sub>L</sub> ≥ 150 Ω		0.1			0.15		Degrees
<b>INPUT CHARACTERISTICS</b>								
Common-Mode Rejection Ratio	DC to 100 kHz, V <sub>CM</sub> = 1.5 V to 3.5 V	86	96		86	96		dB
	V <sub>CM</sub> = 1 V p-p @ 1 MHz	80			80			dB
	V <sub>CM</sub> = 1 V p-p @ 10 MHz		70			70		dB
CMRR with V <sub>OUT</sub> = 1 V p-p	V <sub>CM</sub> = 1 V p-p @ 1 kHz, V <sub>OUT</sub> = ±0.5 V dc		80			72		dB
Common-Mode Voltage Range	V <sub>+IN</sub> - V <sub>-IN</sub> = 0 V		1.25 to 3.7			1.25 to 3.8		V
Differential Operating Range			±0.5			±2.5		V
Differential Clipping Level		±0.6	±0.75	±0.85	±2.3	±2.8	±3.3	V
Resistance	Differential		1			6		MΩ
	Common-Mode		4			4		MΩ
Capacitance	Differential		3			3		pF
	Common-Mode		4			4		pF
<b>DC PERFORMANCE</b>								
Closed-Loop Gain Error	V <sub>OUT</sub> = ±1 V, R <sub>L</sub> ≥ 150 Ω		±0.25	±1.25		±0.1	±0.6	%
	T <sub>MIN</sub> to T <sub>MAX</sub>		20			20		ppm/°C
Open-Loop Gain	V <sub>OUT</sub> = ±1 V		86			71		dB
Gain Nonlinearity	V <sub>OUT</sub> = ±1 V		250			200		ppm
Input Offset Voltage	T <sub>MIN</sub> to T <sub>MAX</sub>		0.2	0.8		0.4	1.8	mV
	T <sub>MIN</sub> to T <sub>MAX</sub>		2			10		μV/°C
Input Offset Voltage vs. Supply	T <sub>MIN</sub> to T <sub>MAX</sub>			1.4			3.5	mV
	+V <sub>S</sub> = 5 V, -V <sub>S</sub> = -0.5 V to +0.5 V		-88	-80		-74	-70	dB
	-V <sub>S</sub> = 0 V, +V <sub>S</sub> = +4.5 V to +5.5 V		-100	-86		-90	-76	dB
Input Bias Current (+IN, -IN)			±0.5	±2		±0.5	±2	μA
Input Bias Current (REF, FB)			±1	±3.5		±1	±3.5	μA
Input Offset Current	T <sub>MIN</sub> to T <sub>MAX</sub> (+IN, -IN, REF, FB)		5			5		nA/°C
	(+IN, -IN, REF, FB)		±0.08	±0.4		±0.08	±0.4	μA
	T <sub>MIN</sub> to T <sub>MAX</sub>		0.2			0.2		nA/°C
<b>OUTPUT PERFORMANCE</b>								
Voltage Swing	R <sub>LOAD</sub> ≥ 150 Ω	1.1		3.9	1.1		3.9	V
Output Current			35			35		mA
Short Circuit Current	To Common		-60/+55			-60/+55		mA
	T <sub>MIN</sub> to T <sub>MAX</sub>		-240			-240		μA/°C
Output Impedance	$\overline{PD} \leq V_{IL}$ , In Power-Down Mode		10			10		pF
<b>POWER SUPPLY</b>								
Operating Voltage Range	Total Supply Voltage	±2.25		±12.6	±2.25		±12.6	V
Quiescent Supply Current	T <sub>MIN</sub> to T <sub>MAX</sub>		9.9	10.6		9.9	10.6	mA
	$\overline{PD} \leq V_{IL}$		0.65	0.85		0.65	0.85	mA
	$\overline{PD} \leq V_{IL}$ , T <sub>MIN</sub> to T <sub>MAX</sub>			1			1	mA
<b><math>\overline{PD}</math> PIN</b>								
V <sub>IH</sub>			+V <sub>S</sub> - 1.5			+V <sub>S</sub> - 1.5		V
V <sub>IL</sub>				+V <sub>S</sub> - 2.5			+V <sub>S</sub> - 2.5	V
I <sub>IH</sub>	$\overline{PD} = \text{Min } V_{IH}$			-30			-30	μA
I <sub>IL</sub>	$\overline{PD} = \text{Max } V_{IL}$			-50			-50	μA
Input Resistance	$\overline{PD} \leq +V_S - 3 \text{ V}$		12.5			12.5		kΩ
	$\overline{PD} \geq +V_S - 2 \text{ V}$		100			100		kΩ
Enable Time			0.5			0.5		μs

Specifications subject to change without notice.

## ABSOLUTE MAXIMUM RATINGS<sup>1,2</sup>

Supply Voltage	26.4 V
Power Dissipation	Refer to Figure 3
Input Voltage (Any Input)	$-V_S - 0.3 \text{ V}$ to $+V_S + 0.3 \text{ V}$
Differential Input Voltage (AD8129) <sup>3</sup>	$V_S \geq \pm 11.5 \text{ V} \dots \pm 0.5 \text{ V}$
Differential Input Voltage (AD8129) <sup>3</sup>	$V_S < \pm 11.5 \text{ V} \dots \pm 6.2 \text{ V}$
Differential Input Voltage (AD8130)	$\pm 8.4 \text{ V}$
Storage Temperature	$-65^\circ\text{C}$ to $+150^\circ\text{C}$
Lead Temperature (Soldering 10 sec)	$300^\circ\text{C}$

### NOTES

<sup>1</sup>Stresses above those listed under Absolute Maximum Ratings may cause permanent damage to the device. This is a stress rating only; functional operation of the device at these or any other conditions above those indicated in the operational section of this specification is not implied. Exposure to absolute maximum rating conditions for extended periods may affect device reliability.

<sup>2</sup>Thermal Resistance measured on SEMI standard 4-layer board.

8-Lead SOIC:  $\theta_{JA} = 121^\circ\text{C/W}$ ; 8-Lead Micro\_SO:  $\theta_{JA} = 142^\circ\text{C/W}$

<sup>3</sup>Refer to Applications section, Extreme Operating Condition, and Power Dissipation.

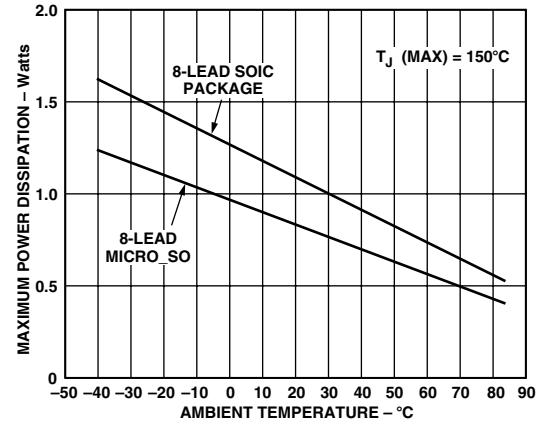
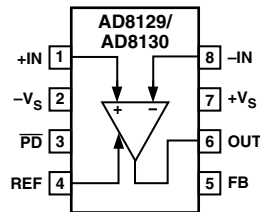

Figure 3. Maximum Power Dissipation vs. Temperature

## CONNECTION DIAGRAM

(Top View)

SO-8 (R) and Micro\_SO-8 (RM)



## ORDERING GUIDE

Model	Temperature Range	Package Description	Package Option	Branding Information
AD8129AR	$-40^\circ\text{C}$ to $+85^\circ\text{C}$	8-Lead SOIC	SO-8	
AD8129AR-REEL <sup>1</sup>	$-40^\circ\text{C}$ to $+85^\circ\text{C}$	8-Lead SOIC	13" Tape and Reel	
AD8129AR-REEL <sup>7</sup> <sup>2</sup>	$-40^\circ\text{C}$ to $+85^\circ\text{C}$	8-Lead SOIC	7" Tape and Reel	
AD8129ARM	$-40^\circ\text{C}$ to $+85^\circ\text{C}$	8-Lead Micro_SO	RM-8	HQA
AD8129ARM-REEL <sup>3</sup>	$-40^\circ\text{C}$ to $+85^\circ\text{C}$	8-Lead Micro_SO	13" Tape and Reel	HQA
AD8129ARM-REEL <sup>7</sup> <sup>2</sup>	$-40^\circ\text{C}$ to $+85^\circ\text{C}$	8-Lead Micro_SO	7" Tape and Reel	HQA
AD8129-EVAL		Evaluation Board with SOIC		
AD8130AR	$-40^\circ\text{C}$ to $+85^\circ\text{C}$	8-Lead SOIC	SO-8	
AD8130AR-REEL <sup>1</sup>	$-40^\circ\text{C}$ to $+85^\circ\text{C}$	8-Lead SOIC	13" Tape and Reel	
AD8130AR-REEL <sup>7</sup> <sup>2</sup>	$-40^\circ\text{C}$ to $+85^\circ\text{C}$	8-Lead SOIC	7" Tape and Reel	
AD8130ARM	$-40^\circ\text{C}$ to $+85^\circ\text{C}$	8-Lead Micro_SO	RM-8	HPA
AD8130ARM-REEL <sup>3</sup>	$-40^\circ\text{C}$ to $+85^\circ\text{C}$	8-Lead Micro_SO	13" Tape and Reel	HPA
AD8130ARM-REEL <sup>7</sup> <sup>2</sup>	$-40^\circ\text{C}$ to $+85^\circ\text{C}$	8-Lead Micro_SO	7" Tape and Reel	HPA
AD8130-EVAL		Evaluation Board with SOIC		

### NOTES

<sup>1</sup>13" Reel of 2500 each.

<sup>2</sup>7" Reel of 1000 each.

<sup>3</sup>13" Reel of 3000 each.

## CAUTION

ESD (electrostatic discharge) sensitive device. Electrostatic charges as high as 4000 V readily accumulate on the human body and test equipment and can discharge without detection. Although the AD8129/AD8130 features proprietary ESD protection circuitry, permanent damage may occur on devices subjected to high-energy electrostatic discharges. Therefore, proper ESD precautions are recommended to avoid performance degradation or loss of functionality.



# AD8129/AD8130

## AD8130 Frequency Response Characteristics

( $G = 1$ ,  $R_L = 1\text{ k}\Omega$ ,  $C_L = 2\text{ pF}$ ,  $V_{OUT} = 0.3\text{ V p-p}$ ,  $T_A = 25^\circ\text{C}$ , unless otherwise noted.)

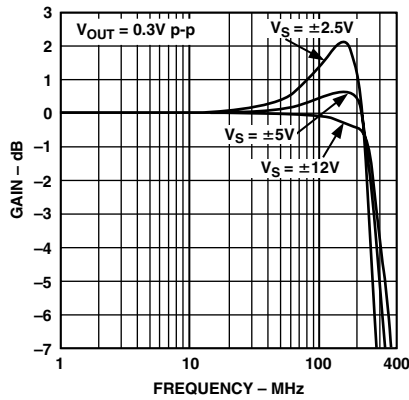

TPC 1. AD8130 Frequency Response vs. Supply,  $V_{OUT} = 0.3\text{ V p-p}$

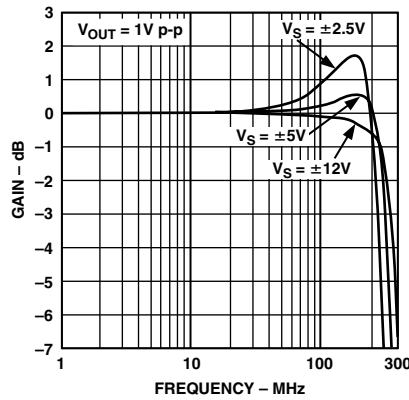

TPC 2. AD8130 Frequency Response vs. Supply,  $V_{OUT} = 1\text{ V p-p}$

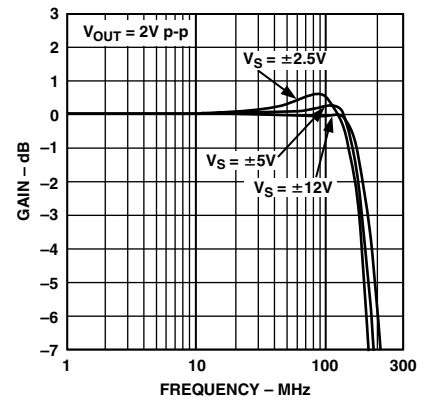

TPC 3. AD8130 Frequency Response vs. Supply,  $V_{OUT} = 2\text{ V p-p}$

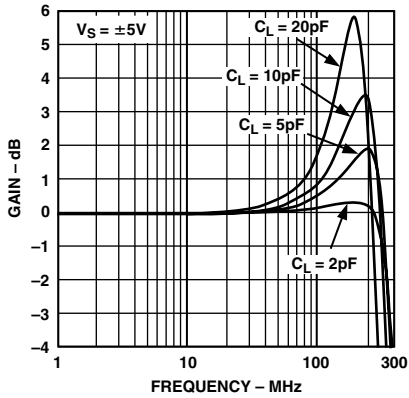

TPC 4. AD8130 Frequency Response vs. Load Capacitance

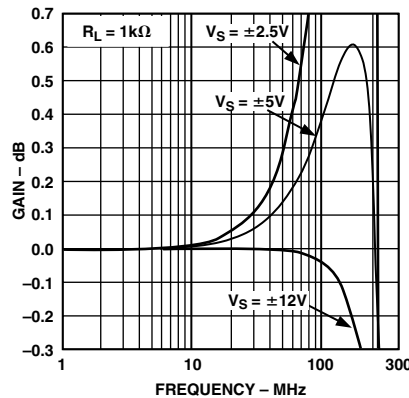

TPC 5. AD8130 Fine Scale Response vs. Supply,  $R_L = 1\text{ k}\Omega$

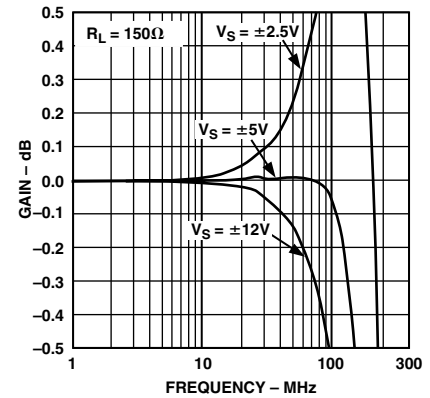

TPC 6. AD8130 Fine Scale Response vs. Supply,  $R_L = 150\ \Omega$

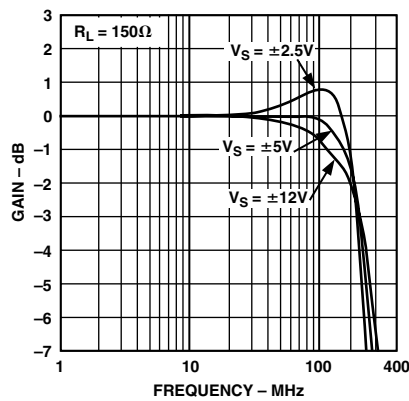

TPC 7. AD8130 Frequency Response vs. Supply,  $R_L = 150\ \Omega$

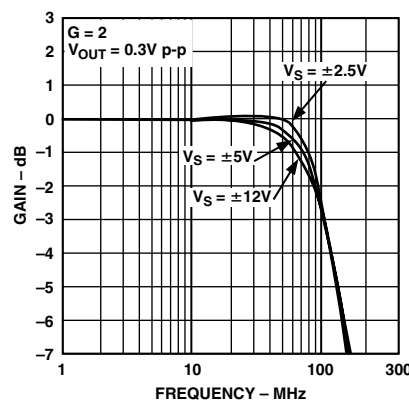

TPC 8. AD8130 Frequency Response vs. Supply,  $G = 2$ ,  $V_{OUT} = 0.3\text{ V p-p}$

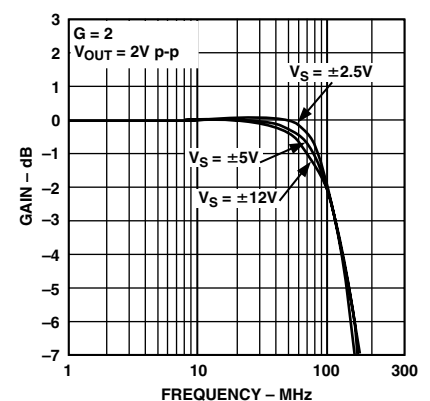

TPC 9. AD8130 Frequency Response vs. Supply,  $G = 2$ ,  $V_{OUT} = 2\text{ V p-p}$

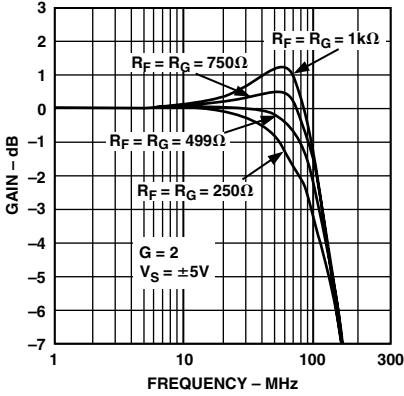

TPC 10. AD8130 Frequency Response for Various  $R_F/R_G$

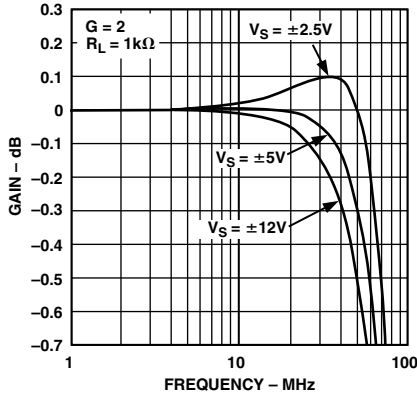

TPC 11. AD8130 Fine Scale Response vs. Supply,  $G = 2$ ,  $R_L = 1 \text{ k}\Omega$

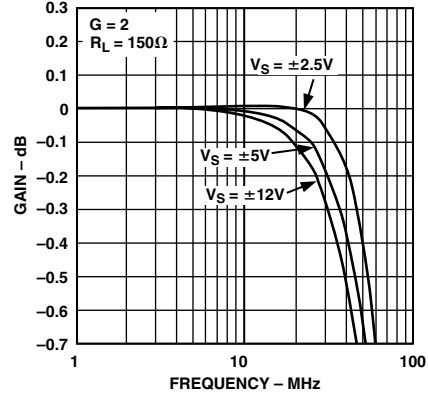

TPC 12. AD8130 Fine Scale Response vs. Supply,  $G = 2$ ,  $R_L = 150 \Omega$

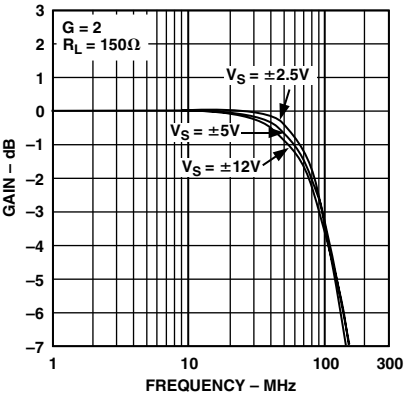

TPC 13. AD8130 Frequency Response vs. Supply,  $G = 2$ ,  $R_L = 150 \Omega$

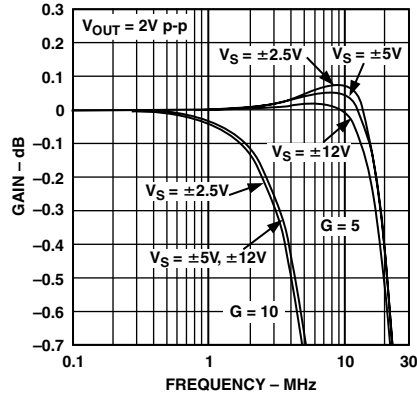

TPC 14. AD8130 Fine Scale Response vs. Supply,  $G = 5$ ,  $G = 10$ ,  $V_{OUT} = 2 \text{ V p-p}$

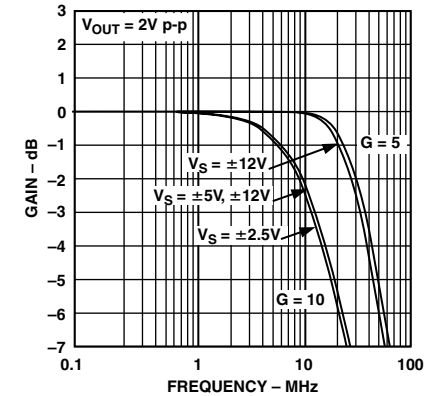

TPC 15. AD8130 Frequency Response vs. Supply,  $G = 5$ ,  $G = 10$ ,  $V_{OUT} = 2 \text{ V p-p}$

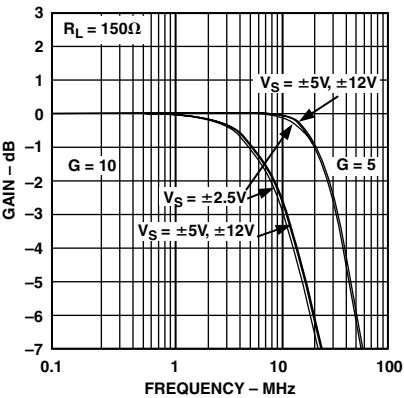

TPC 16. AD8130 Frequency Response vs. Supply,  $G = 5$ ,  $G = 10$ ,  $R_L = 150 \Omega$

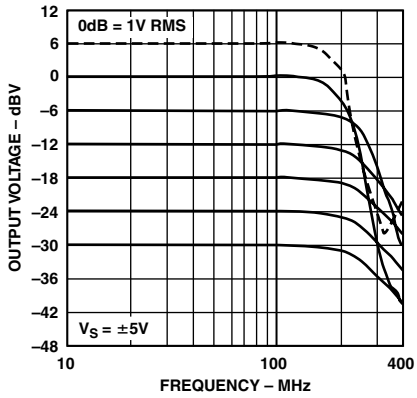

TPC 17. AD8130 Frequency Response for Various Output Levels

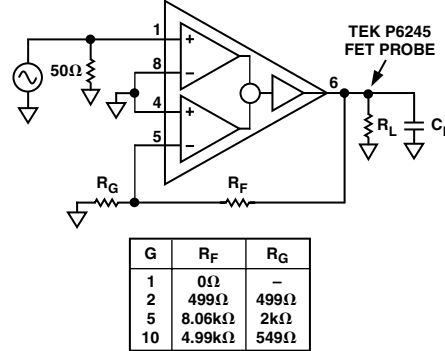

TPC 18. AD8130 Basic Frequency Response Test Circuit

# AD8129/AD8130

## AD8129 Frequency Response Characteristics

( $G = 10$ ,  $R_L = 1\text{ k}\Omega$ ,  $C_L = 2\text{ pF}$ ,  $V_{OUT} = 0.3\text{ V p-p}$ ,  $T_A = 25^\circ\text{C}$ , unless otherwise noted.)

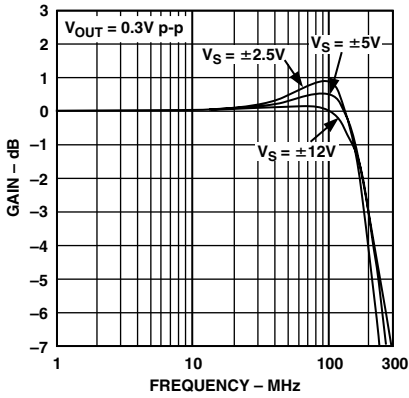

TPC 19. AD8129 Frequency Response vs. Supply,  $V_{OUT} = 0.3\text{ V p-p}$

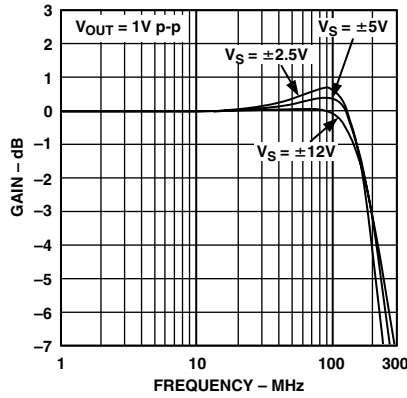

TPC 20. AD8129 Frequency Response vs. Supply,  $V_{OUT} = 1\text{ V p-p}$

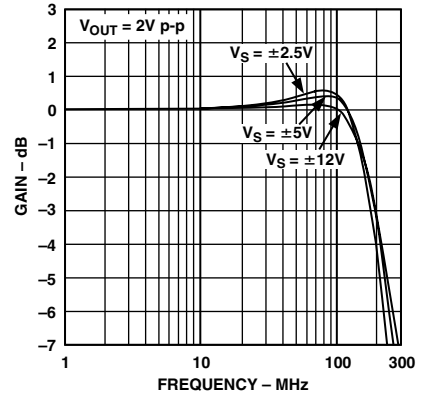

TPC 21. AD8129 Frequency Response vs. Supply,  $V_{OUT} = 2\text{ V p-p}$

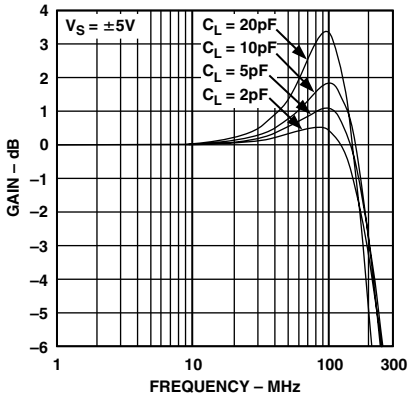

TPC 22. AD8129 Frequency Response vs. Load Capacitance

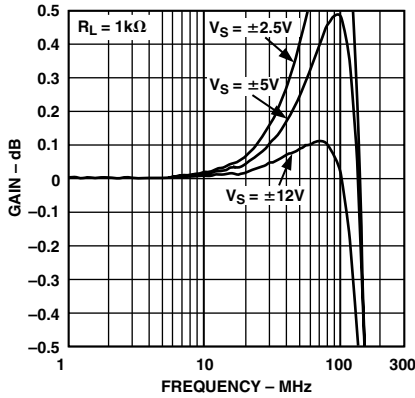

TPC 23. AD8129 Fine Scale Response vs. Supply,  $R_L = 1\text{ k}\Omega$

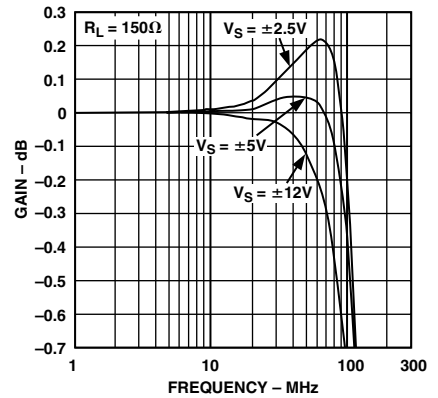

TPC 24. AD8129 Fine Scale Response vs. Supply,  $R_L = 150\ \Omega$

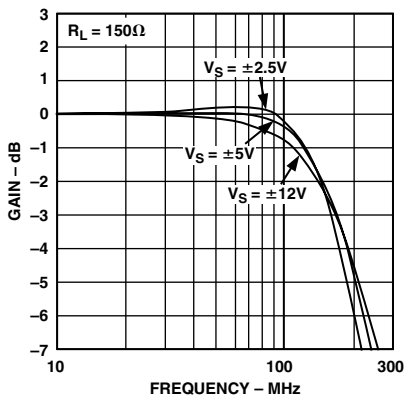

TPC 25. AD8129 Frequency Response vs. Supply,  $R_L = 150\ \Omega$

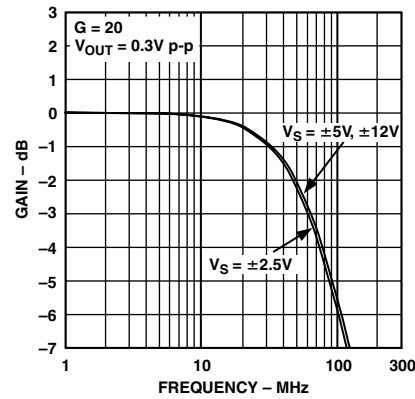

TPC 26. AD8129 Frequency Response vs. Supply,  $G = 20$ ,  $V_{OUT} = 0.3\text{ V p-p}$

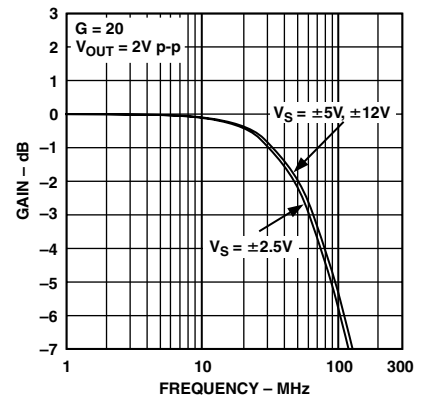

TPC 27. AD8129 Frequency Response vs. Supply,  $G = 20$ ,  $V_{OUT} = 2\text{ V p-p}$



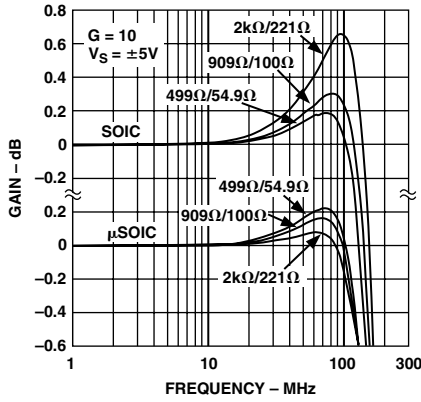

TPC 28. AD8129 Fine Scale Response vs. SOIC and  $\mu$ SOIC for Various  $R_F/R_G$

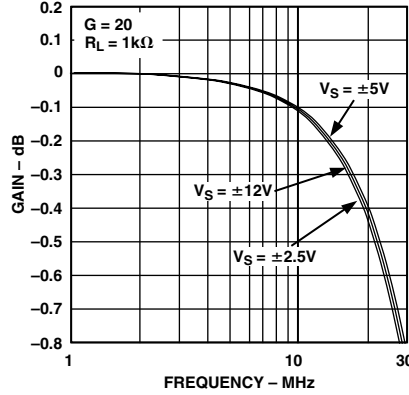

TPC 29. AD8129 Fine Scale Response vs. Supply

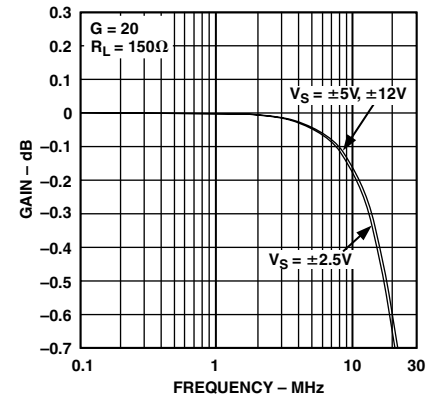

TPC 30. AD8129 Fine Scale Response vs. Supply

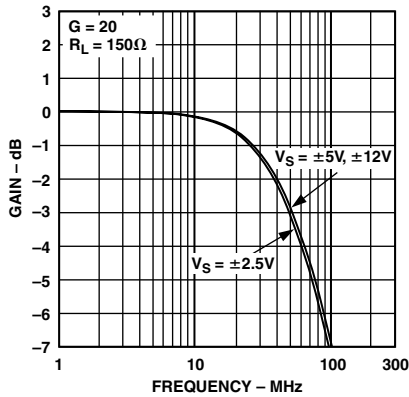

TPC 31. AD8129 Frequency Response vs. Supply,  $G = 20$ ,  $R_L = 150 \Omega$

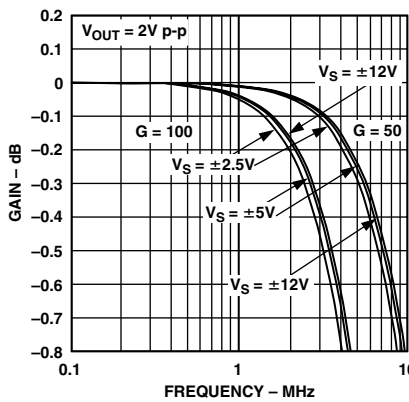

TPC 32. AD8129 Fine Scale Response vs. Supply,  $G = 50$ ,  $G = 100$ ,  $V_{OUT} = 2 V p-p$

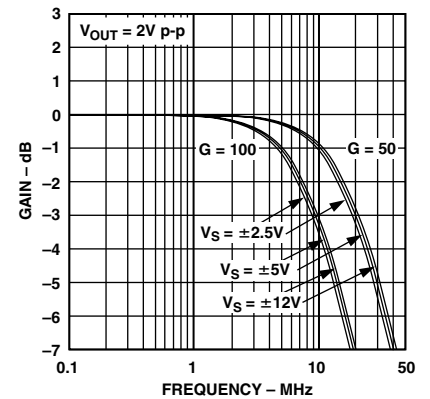

TPC 33. AD8129 Frequency Response vs. Supply,  $G = 50$ ,  $G = 100$ ,  $V_{OUT} = 2 V p-p$

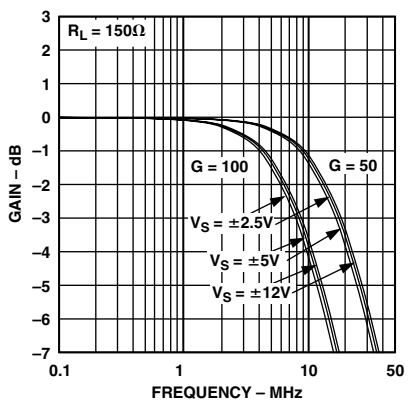

TPC 34. AD8129 Frequency Response vs. Supply,  $G = 50$ ,  $G = 100$ ,  $R_L = 150 \Omega$

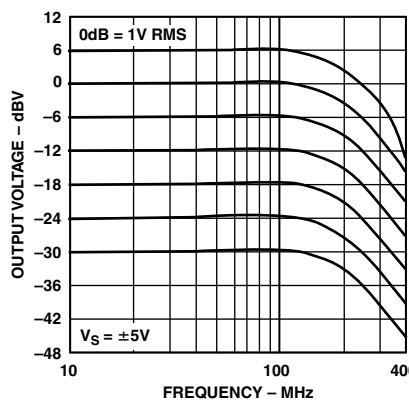

TPC 35. AD8129 Frequency Response for Various Output Levels

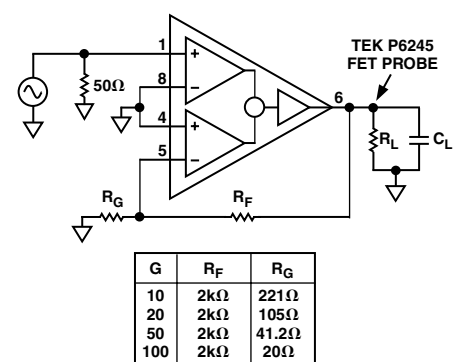

TPC 36. AD8129 Basic Frequency Response Test Circuit

# AD8129/AD8130

## AD8130 Harmonic Distortion Characteristics

( $R_L = 1\text{ k}\Omega$ ,  $C_L = 2\text{ pF}$ ,  $T_A = 25^\circ\text{C}$ , unless otherwise noted.)

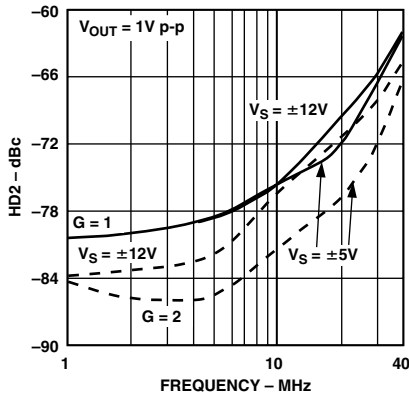

TPC 37. AD8130 Second Harmonic Distortion vs. Frequency

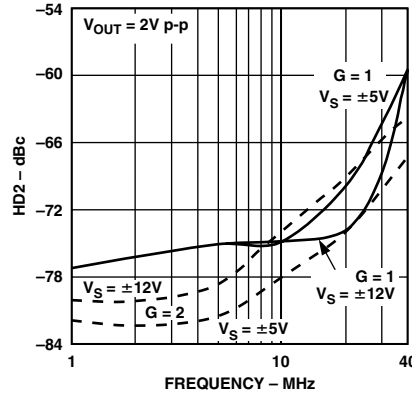

TPC 38. AD8130 Second Harmonic Distortion vs. Frequency

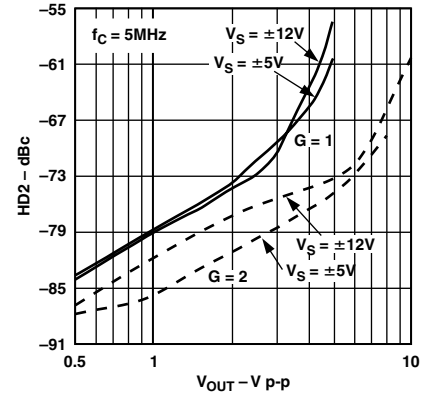

TPC 39. AD8130 Second Harmonic Distortion vs. Output Voltage

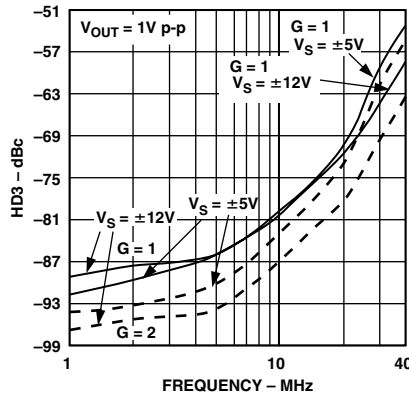

TPC 40. AD8130 Third Harmonic Distortion vs. Frequency

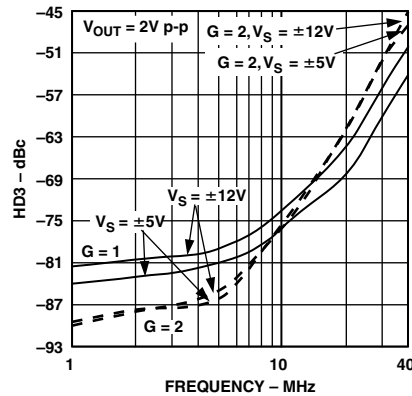

TPC 41. AD8130 Third Harmonic Distortion vs. Frequency

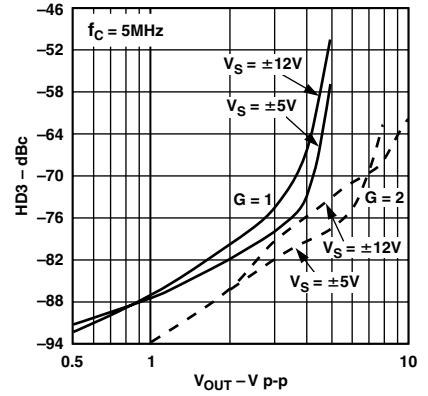

TPC 42. AD8130 Third Harmonic Distortion vs. Output Voltage

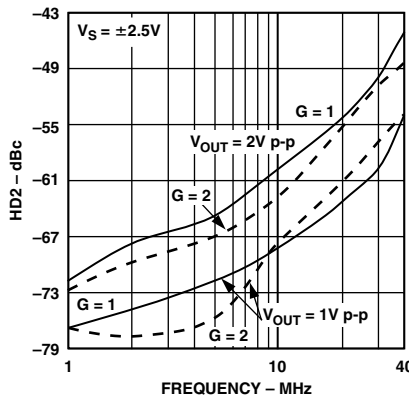

TPC 43. AD8130 Second Harmonic Distortion vs. Frequency

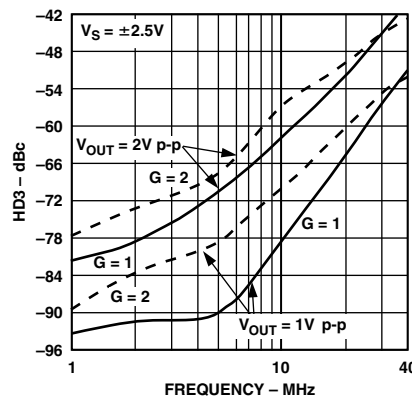

TPC 44. AD8130 Third Harmonic Distortion vs. Frequency

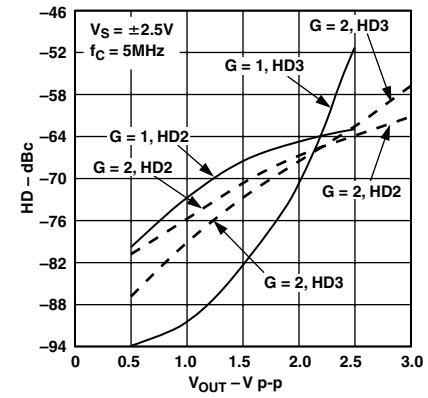

TPC 45. AD8130 Harmonic Distortion vs. Output Voltage

# AD8129 Harmonic Distortion Characteristics

( $R_L = 1\text{ k}\Omega$ ,  $C_L = 2\text{ pF}$ ,  $T_A = 25^\circ\text{C}$ , unless otherwise noted.)

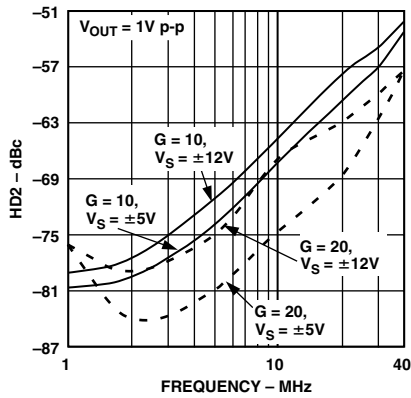

TPC 46. AD8129 Second Harmonic Distortion vs. Frequency

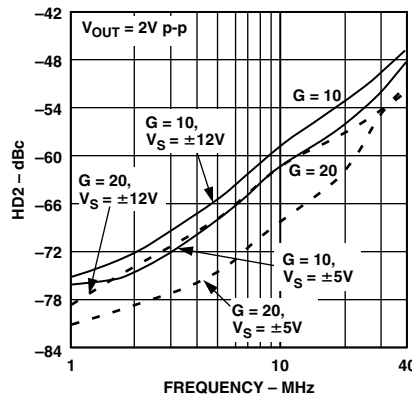

TPC 47. AD8129 Second Harmonic Distortion vs. Frequency

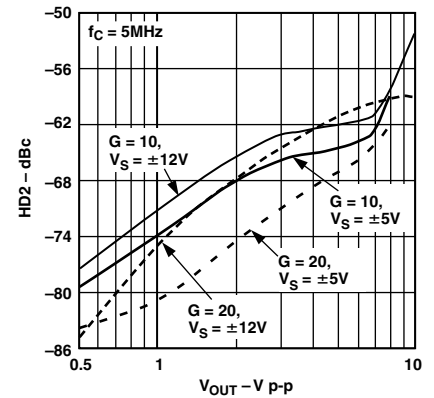

TPC 48. AD8129 Second Harmonic Distortion vs. Output Voltage

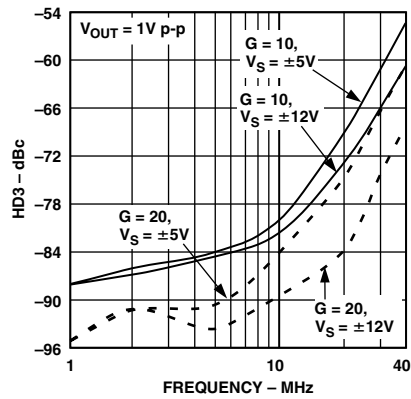

TPC 49. AD8129 Third Harmonic Distortion vs. Frequency

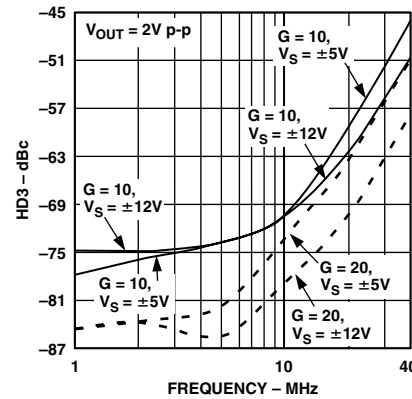

TPC 50. AD8129 Third Harmonic Distortion vs. Frequency

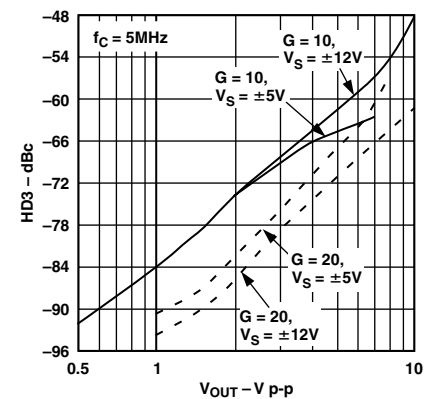

TPC 51. AD8129 Third Harmonic Distortion vs. Output Voltage

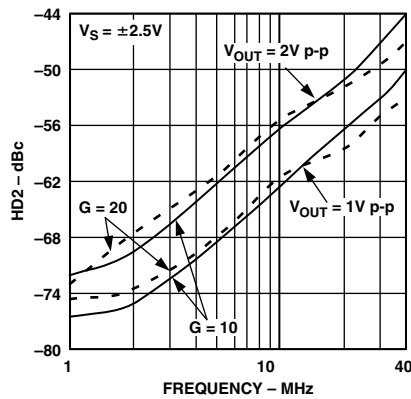

TPC 52. AD8129 Second Harmonic Distortion vs. Frequency

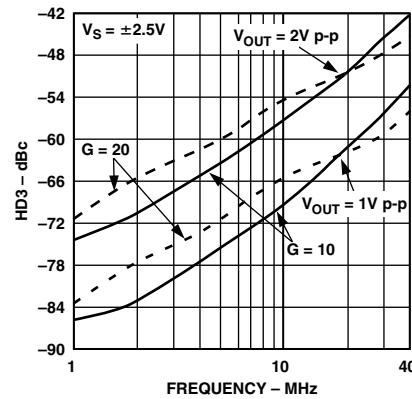

TPC 53. AD8129 Third Harmonic Distortion vs. Frequency

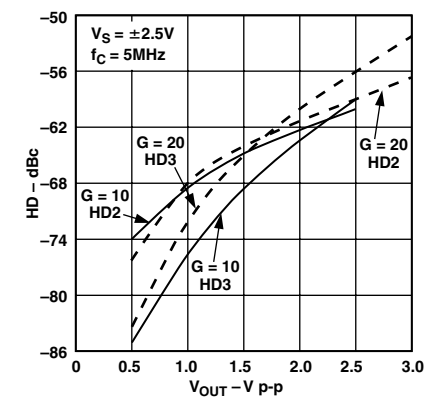

TPC 54. AD8129 Harmonic Distortion vs. Output Voltage

# AD8129/AD8130

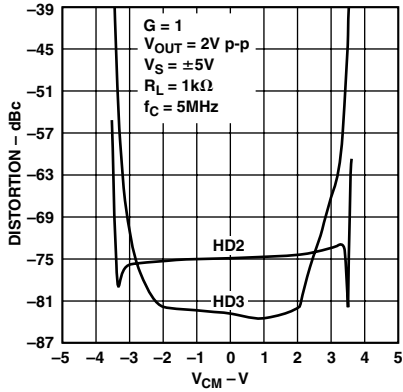

TPC 55. AD8130 Harmonic Distortion vs. Common-Mode Voltage

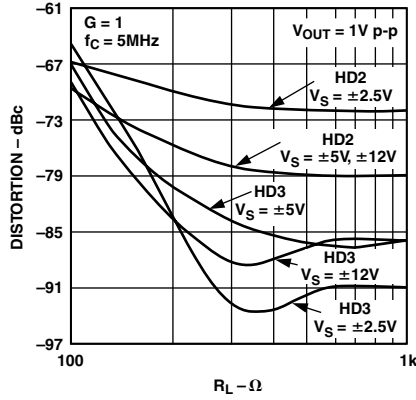

TPC 56. AD8130 Harmonic Distortion vs. Load Resistance

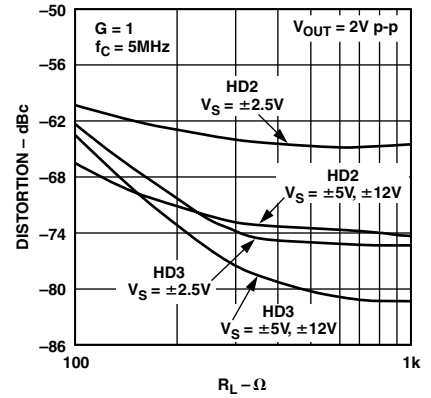

TPC 57. AD8130 Harmonic Distortion vs. Load Resistance

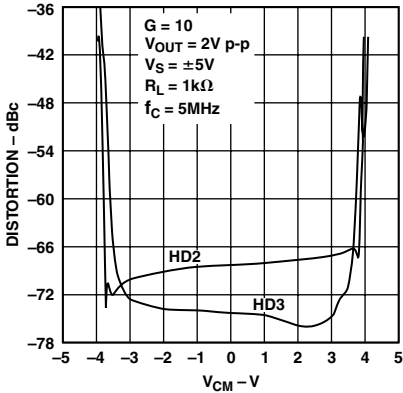

TPC 58. AD8129 Harmonic Distortion vs. Common-Mode Voltage

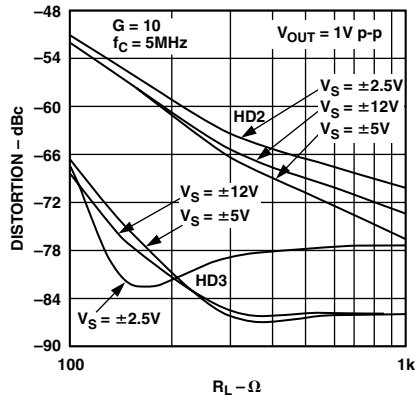

TPC 59. AD8129 Harmonic Distortion vs. Load Resistance

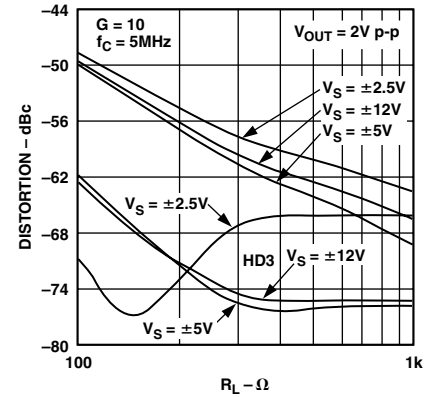

TPC 60. AD8129 Harmonic Distortion vs. Load Resistance

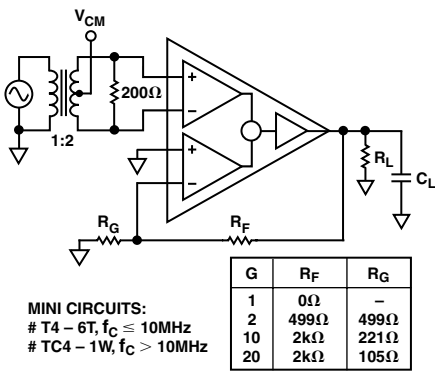

TPC 61. AD8129/AD8130 Basic Distortion Test Circuit,  $V_{CM} = 0\text{V}$  Unless Otherwise Noted

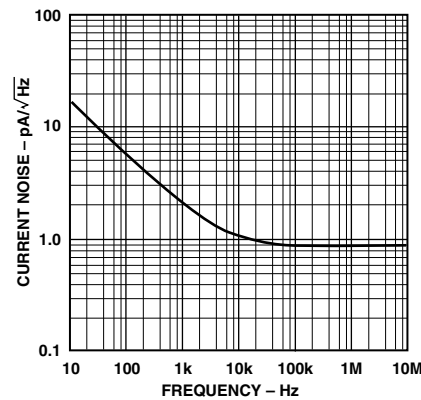

TPC 62. AD8129/AD8130 Input Current Noise vs. Frequency

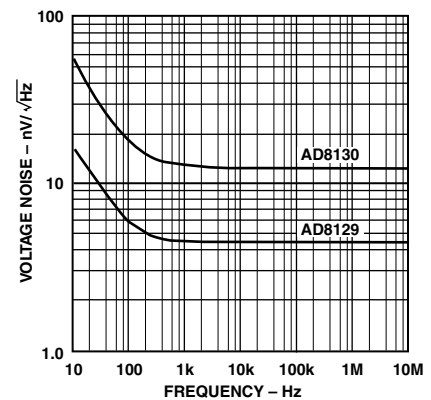

TPC 63. AD8129/AD8130 Input Voltage Noise vs. Frequency

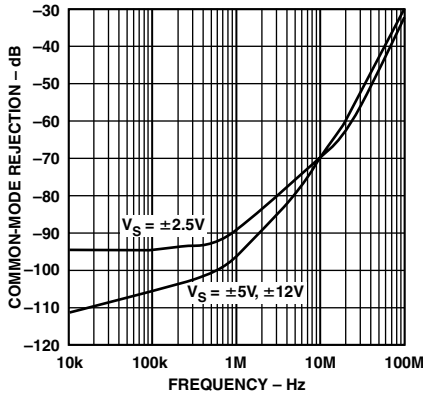

TPC 64. AD8130 Common-Mode Rejection vs. Frequency

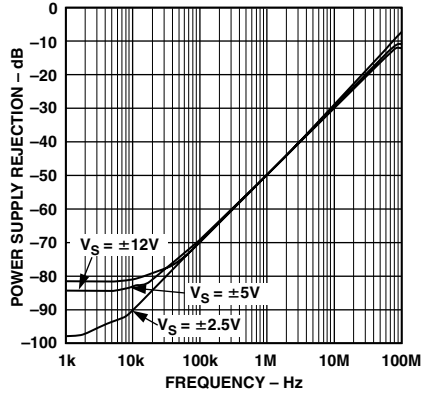

TPC 65. AD8130 Positive Power Supply Rejection vs. Frequency

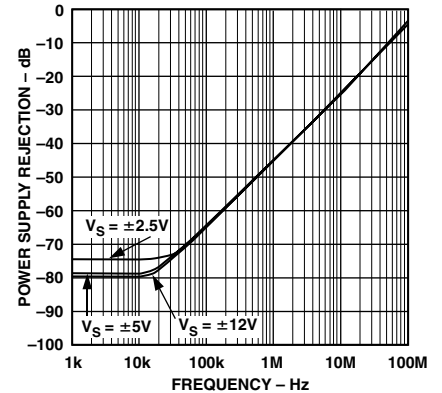

TPC 66. AD8130 Negative Power Supply Rejection vs. Frequency

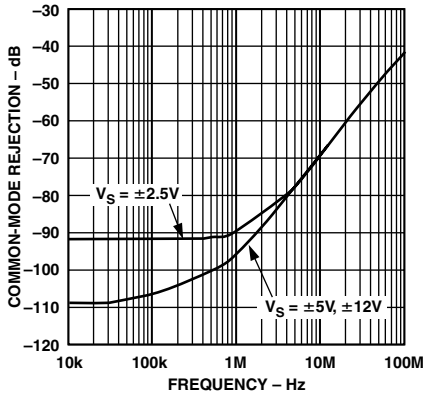

TPC 67. AD8129 Common-Mode Rejection vs. Frequency

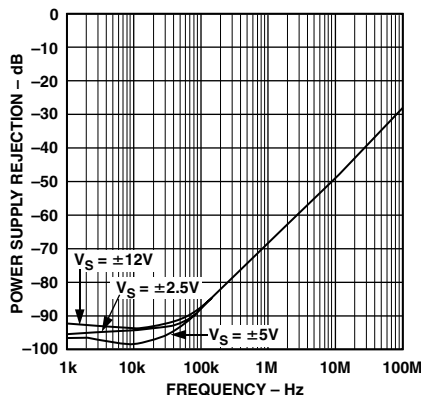

TPC 68. AD8129 Positive Power Supply Rejection vs. Frequency

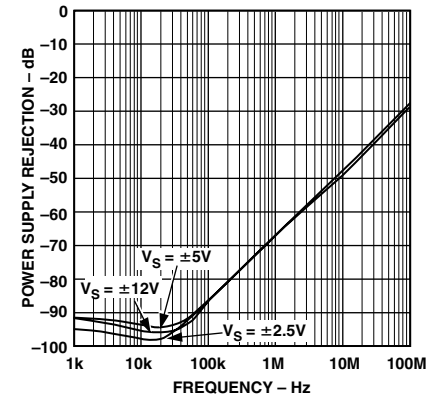

TPC 69. AD8129 Negative Power Supply Rejection vs. Frequency

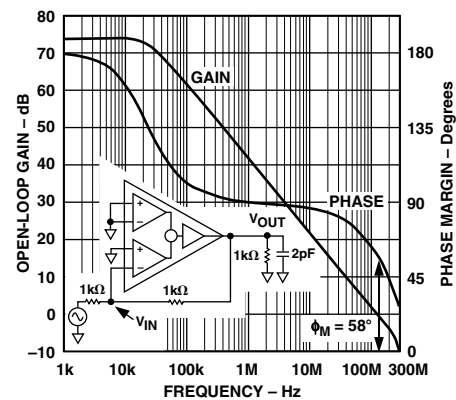

TPC 70. AD8130 Open Loop Gain and Phase vs. Frequency

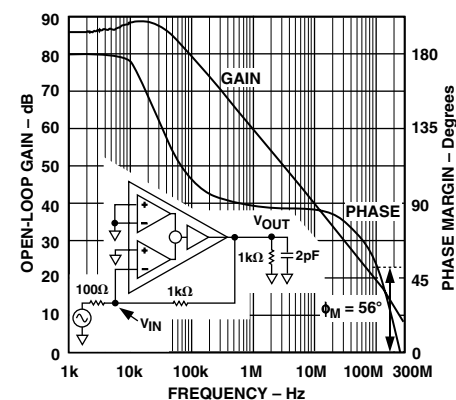

TPC 71. AD8129 Open Loop Gain and Phase vs. Frequency

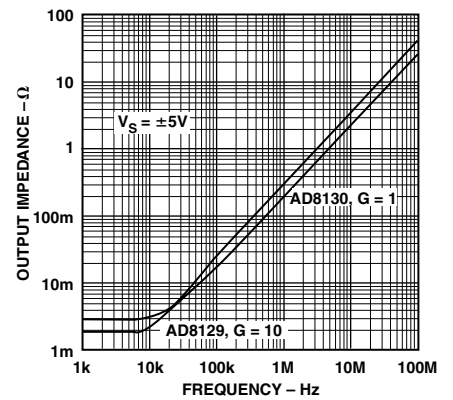

TPC 72. Closed-Loop Output Impedance vs. Frequency

# AD8129/AD8130

## AD8130 Transient Response Characteristics

( $G = 1$ ,  $R_L = 1\text{ k}\Omega$ ,  $C_L = 2\text{ pF}$ ,  $V_S = \pm 5\text{ V}$ ,  $T_A = 25^\circ\text{C}$ , unless otherwise noted.)

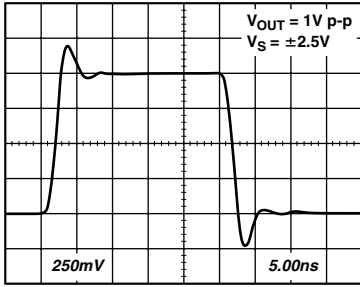

TPC 73. AD8130 Transient Response,  $V_S = \pm 2.5\text{ V}$ ,  $V_{OUT} = 1\text{ V p-p}$

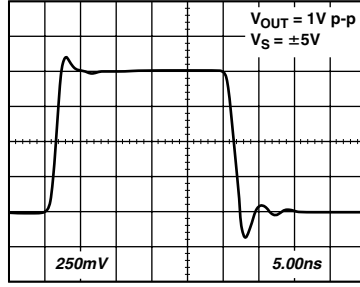

TPC 74. AD8130 Transient Response,  $V_S = \pm 5\text{ V}$ ,  $V_{OUT} = 1\text{ V p-p}$

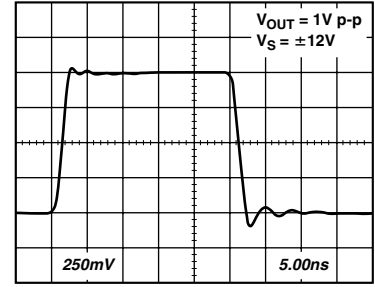

TPC 75. AD8130 Transient Response,  $V_S = \pm 12\text{ V}$ ,  $V_{OUT} = 1\text{ V p-p}$

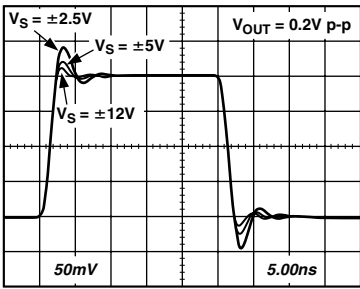

TPC 76. AD8130 Transient Response vs. Supply,  $V_{OUT} = 0.2\text{ V p-p}$

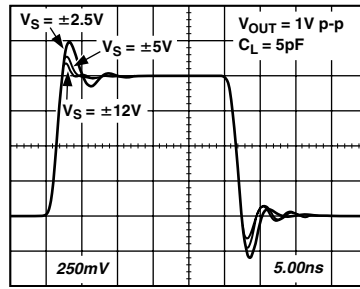

TPC 77. AD8130 Transient Response vs. Supply,  $V_{OUT} = 1\text{ V p-p}$ ,  $C_L = 5\text{ pF}$

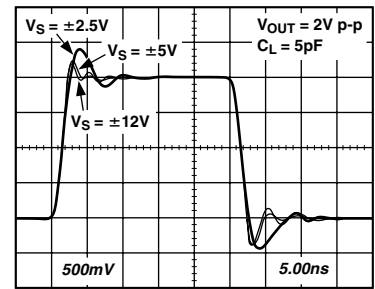

TPC 78. AD8130 Transient Response vs. Supply,  $V_{OUT} = 2\text{ V p-p}$ ,  $C_L = 5\text{ pF}$

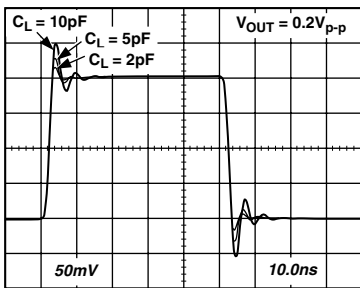

TPC 79. AD8130 Transient Response vs. Load Capacitance,  $V_{OUT} = 0.2\text{ V p-p}$

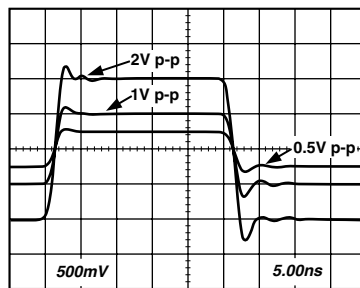

TPC 80. AD8130 Transient Response vs. Output Amplitude,  $V_{OUT} = 0.5\text{ V p-p}$ ,  $1\text{ V p-p}$ ,  $2\text{ V p-p}$

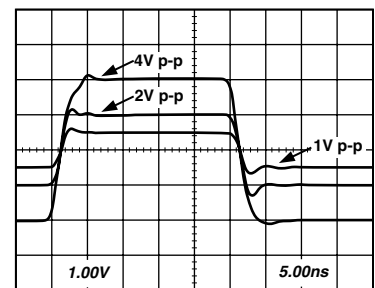

TPC 81. AD8130 Transient Response vs. Output Amplitude,  $V_{OUT} = 1\text{ V p-p}$ ,  $2\text{ V p-p}$ ,  $4\text{ V p-p}$

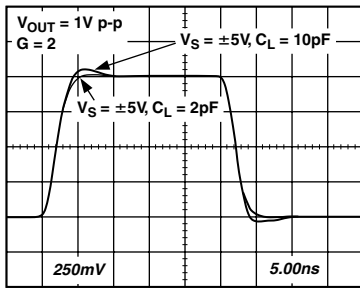

TPC 82. AD8130 Transient Response vs. Load Capacitance,  $V_{OUT} = 1\ V\ p-p$ ,  $G = 2$

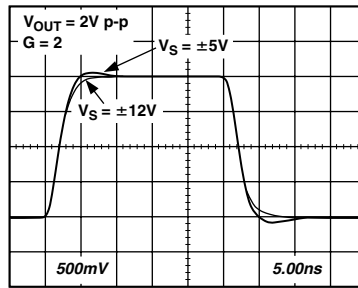

TPC 83. AD8130 Transient Response vs. Supply,  $V_{OUT} = 2\ V\ p-p$ ,  $G = 2$

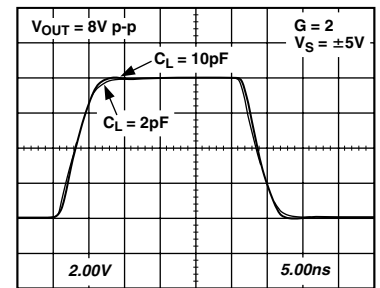

TPC 84. AD8130 Transient Response vs. Load Capacitance,  $V_{OUT} = 8\ V\ p-p$

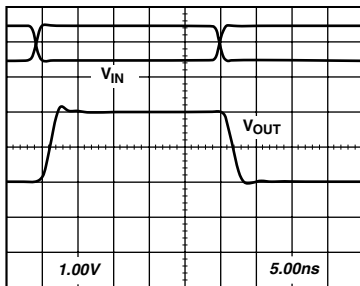

TPC 85. AD8130 Transient Response with +3 V Common-Mode Input

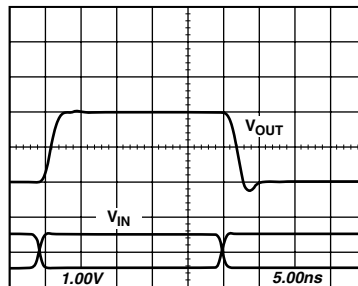

TPC 86. AD8130 Transient Response with -3 V Common-Mode Input

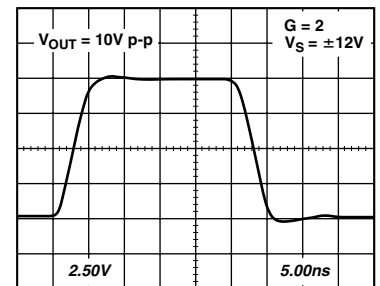

TPC 87. AD8130 Transient Response,  $V_{OUT} = 10\ V\ p-p$ ,  $G = 2$ ,  $V_S = \pm 12\ V$

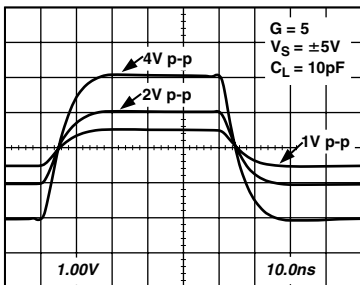

TPC 88. AD8130 Transient Response vs. Output Amplitude

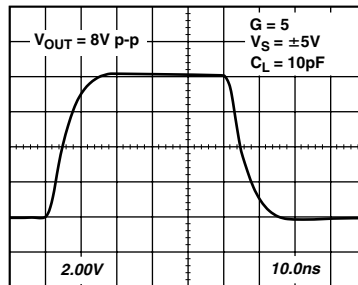

TPC 89. AD8130 Transient Response,  $V_{OUT} = 8\ V\ p-p$ ,  $G = 5$ ,  $V_S = \pm 5\ V$

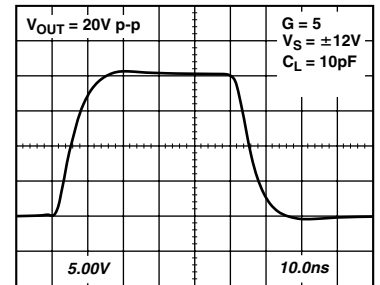

TPC 90. AD8130 Transient Response,  $V_{OUT} = 20\ V\ p-p$ ,  $G = 5$ ,  $V_S = \pm 12\ V$

# AD8129/AD8130

## AD8129 Transient Response Characteristics

( $G = 10$ ,  $R_F = 2 \text{ k}\Omega$ ,  $R_G = 221 \text{ }\Omega$ ,  $R_L = 1 \text{ k}\Omega$ ,  $C_L = 1 \text{ pF}$ ,  $V_S = \pm 5 \text{ V}$ ,  $T_A = 25^\circ\text{C}$ , unless otherwise noted.)

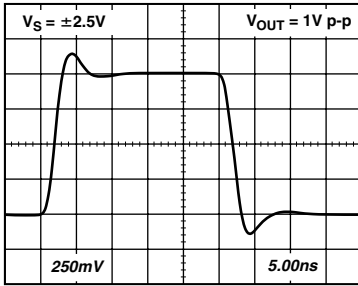

TPC 91. AD8129 Transient Response,  $V_S = \pm 2.5 \text{ V}$ ,  $V_{OUT} = 1 \text{ V p-p}$

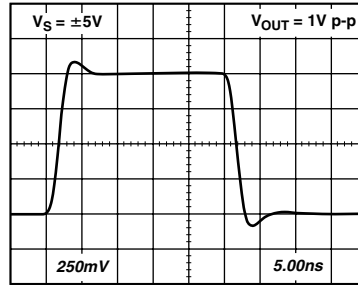

TPC 92. AD8129 Transient Response,  $V_S = \pm 5 \text{ V}$ ,  $V_{OUT} = 1 \text{ V p-p}$

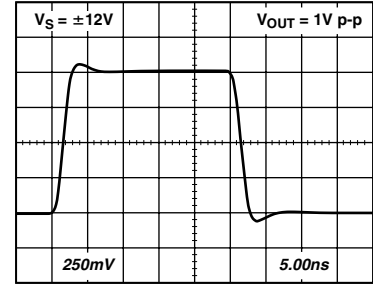

TPC 93. AD8129 Transient Response,  $V_S = \pm 12 \text{ V}$ ,  $V_{OUT} = 1 \text{ V p-p}$

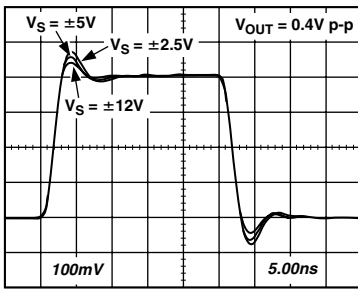

TPC 94. AD8129 Transient Response vs. Supply,  $V_{OUT} = 0.4 \text{ V p-p}$

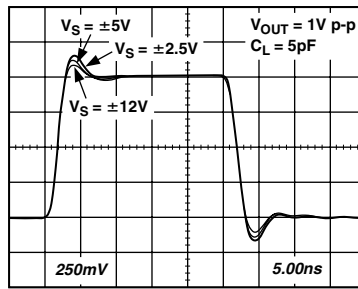

TPC 95. AD8129 Transient Response vs. Supply,  $V_{OUT} = 1 \text{ V p-p}$ ,  $C_L = 5 \text{ pF}$

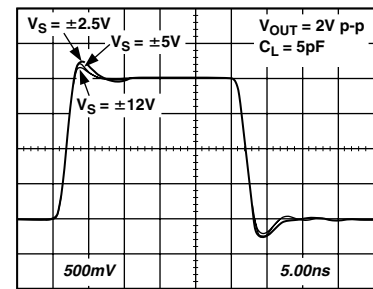

TPC 96. AD8129 Transient Response vs. Supply,  $V_{OUT} = 2 \text{ V p-p}$ ,  $C_L = 5 \text{ pF}$

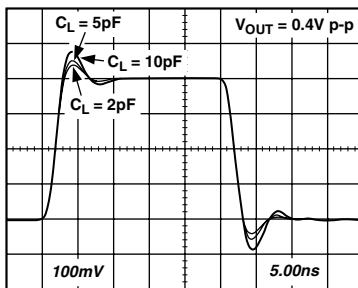

TPC 97. AD8129 Transient Response vs. Load Capacitance,  $V_{OUT} = 0.4 \text{ V p-p}$

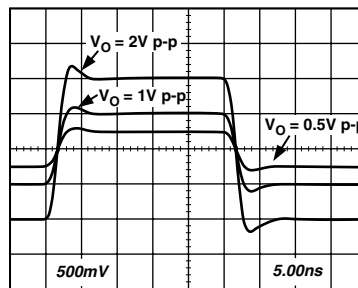

TPC 98. AD8129 Transient Response vs. Output Amplitude,  $V_{OUT} = 0.5 \text{ V p-p}$ ,  $1 \text{ V p-p}$ ,  $2 \text{ V p-p}$

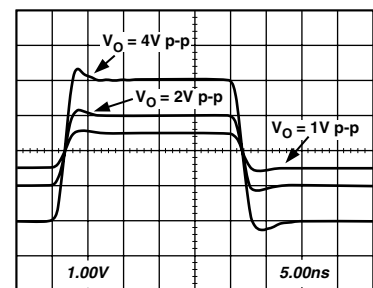

TPC 99. AD8129 Transient Response vs. Output Amplitude,  $V_{OUT} = 1 \text{ V p-p}$ ,  $2 \text{ V p-p}$ ,  $4 \text{ V p-p}$



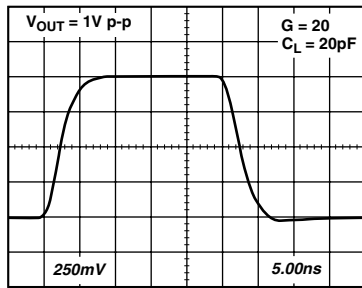

TPC 100. AD8129 Transient Response,  $V_{OUT} = 1\text{ V p-p}$ ,  $V_S = \pm 2.5\text{ V to } \pm 12\text{ V}$

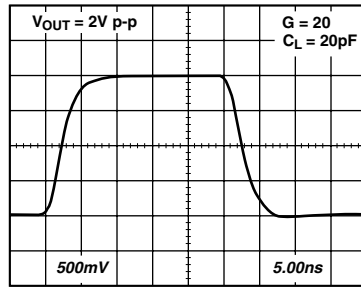

TPC 101. AD8129 Transient Response,  $V_{OUT} = 2\text{ V p-p}$ ,  $V_S = \pm 5\text{ V}$

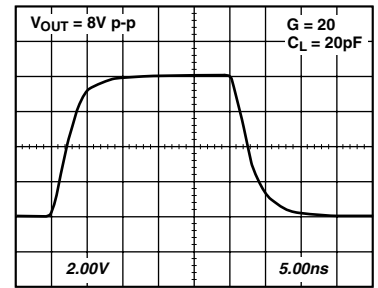

TPC 102. AD8129 Transient Response,  $V_{OUT} = 8\text{ V p-p}$ ,  $V_S = \pm 5\text{ V}$

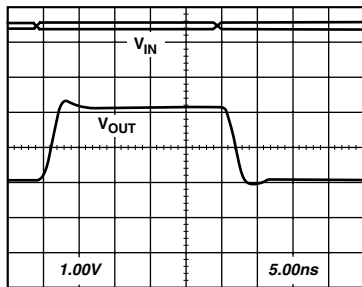

TPC 103. AD8129 Transient Response with  $+3.5\text{ V}$  Common-Mode Input

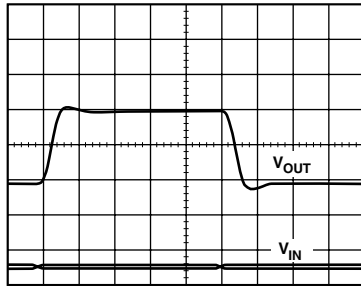

TPC 104. AD8129 Transient Response with  $-3.5\text{ V}$  Common-Mode Input

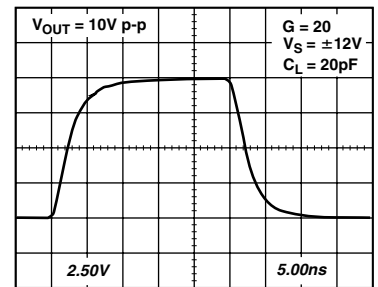

TPC 105. AD8129 Transient Response,  $V_{OUT} = 10\text{ V p-p}$ ,  $G = 20$

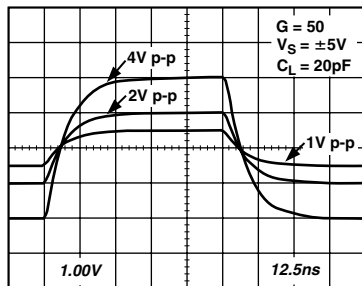

TPC 106. AD8129 Transient Response vs. Output Amplitude,  $V_{OUT} = 1\text{ V p-p}$ ,  $2\text{ V p-p}$ ,  $4\text{ V p-p}$

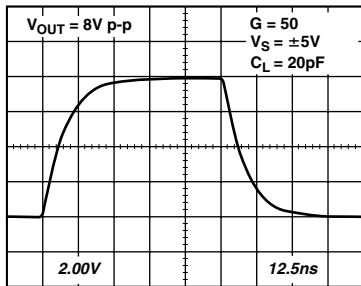

TPC 107. AD8129 Transient Response,  $V_{OUT} = 8\text{ V p-p}$ ,  $G = 50$ ,  $V_S = \pm 5\text{ V}$

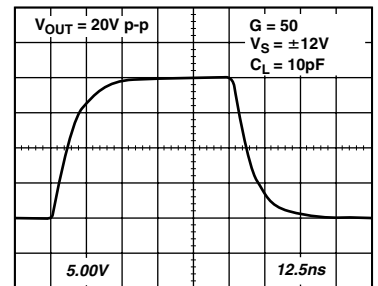

TPC 108. AD8129 Transient Response,  $V_{OUT} = 20\text{ V p-p}$ ,  $G = 50$ ,  $V_S = \pm 12\text{ V}$

# AD8129/AD8130

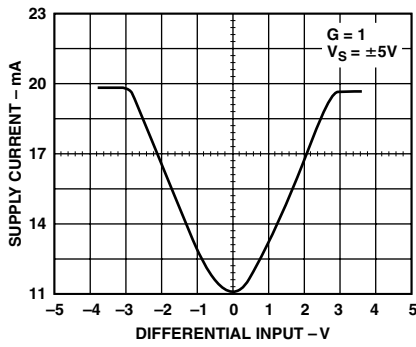

TPC 109. AD8130 DC Power Supply Current vs. Differential Input Voltage

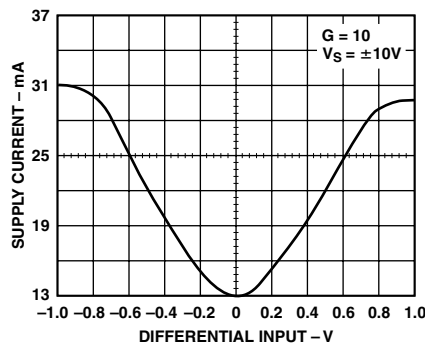

TPC 110. AD8129 DC Power Supply Current vs. Differential Input Voltage

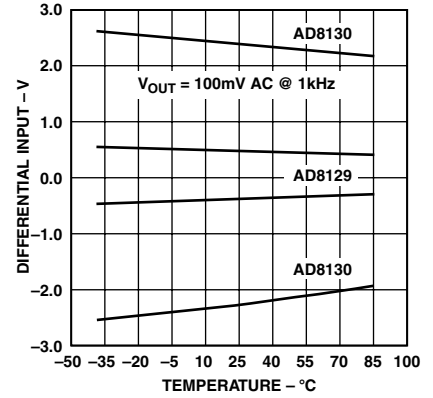

TPC 111. AD8129/AD8130 Input Differential Voltage Range vs. Temperature, 1% Gain Compression

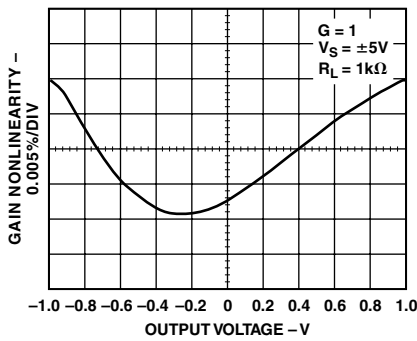

TPC 112. AD8130 Gain Nonlinearity,  $V_{OUT} = 2\text{ V p-p}$

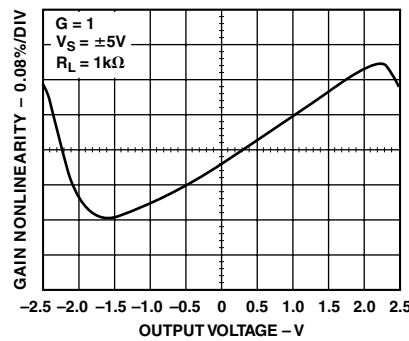

TPC 113. AD8130 Gain Nonlinearity,  $V_{OUT} = 5\text{ V p-p}$

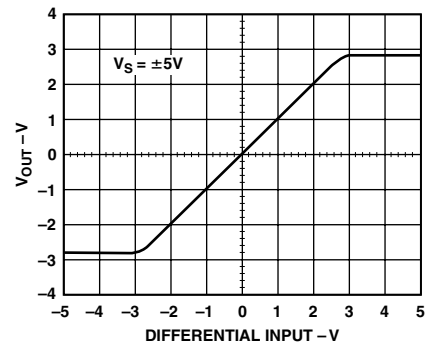

TPC 114. AD8130 Differential Input Clipping Level

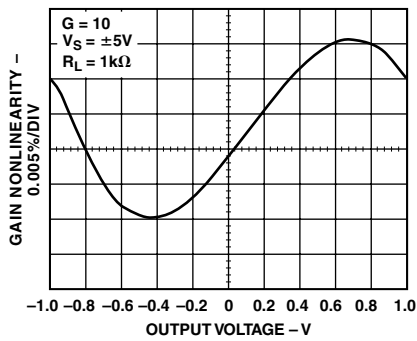

TPC 115. AD8129 Gain Nonlinearity,  $V_{OUT} = 2\text{ V p-p}$

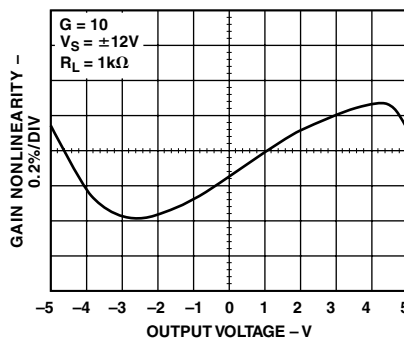

TPC 116. AD8129 Gain Nonlinearity,  $V_{OUT} = 10\text{ V p-p}$

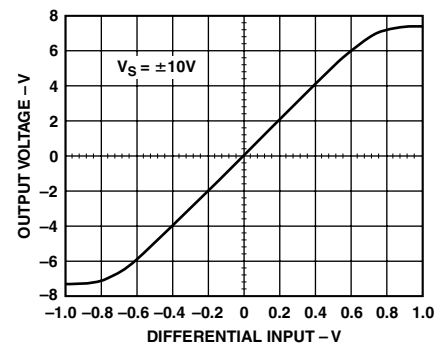

TPC 117. AD8129 Differential Input Clipping Level

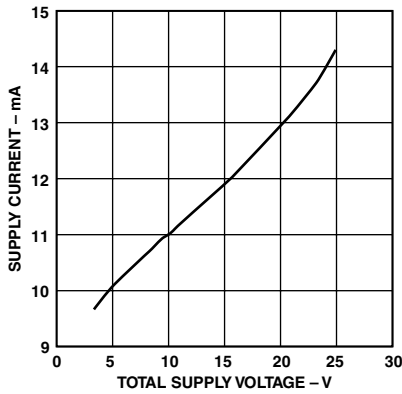

TPC 118. Quiescent Power Supply Current vs. Total Supply Voltage

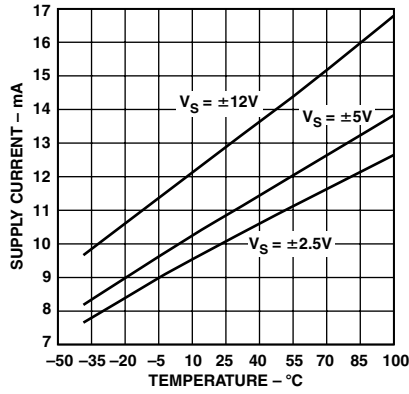

TPC 119. Quiescent Power Supply Current vs. Temperature

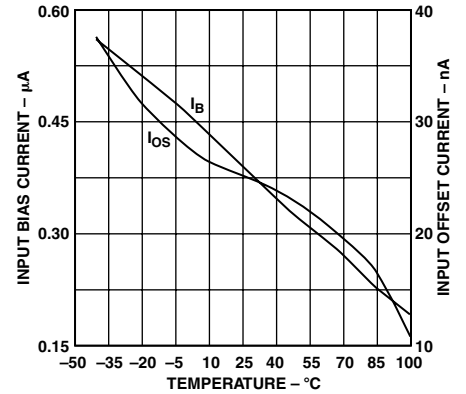

TPC 120. Input Bias Current and Input Offset Current vs. Temperature

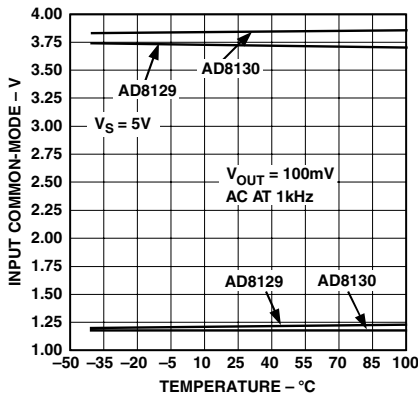

TPC 121. Common-Mode Voltage Range vs. Temperature, Typical 1% Gain Compression

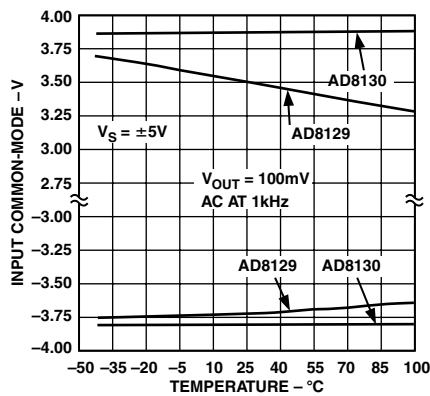

TPC 122. Common-Mode Voltage Range vs. Temperature, Typical 1% Gain Compression

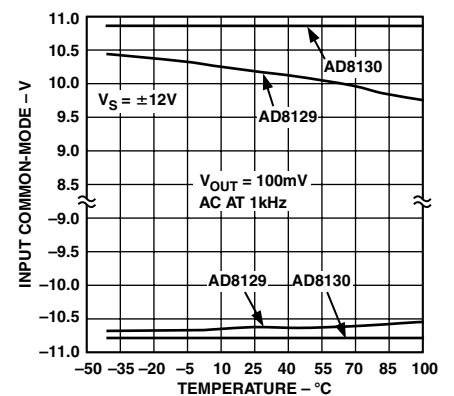

TPC 123. Common-Mode Voltage Range vs. Temperature, Typical 1% Gain Compression

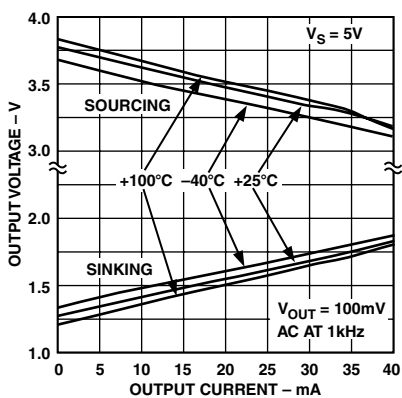

TPC 124. Output Voltage Range vs. Output Current, Typical 1% Gain Compression

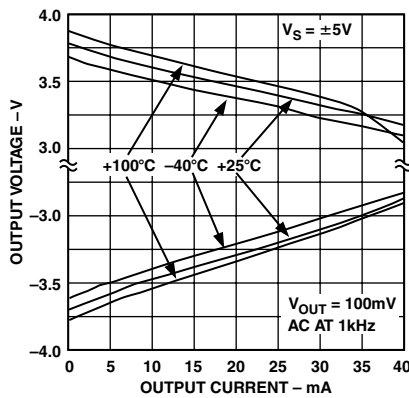

TPC 125. Output Voltage Range vs. Output Current, Typical 1% Gain Compression

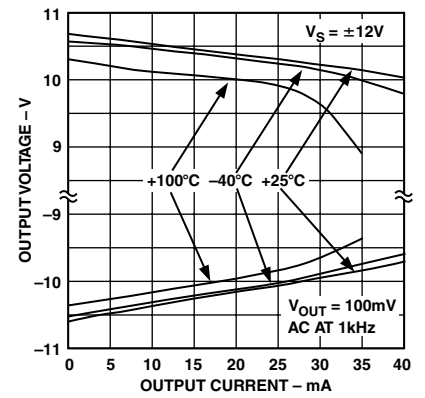

TPC 126. Output Voltage Range vs. Output Current, Typical 1% Gain Compression

# AD8129/AD8130

## THEORY OF OPERATION

The AD8129/AD8130 use an architecture called active feedback which differs from that of conventional op amps. The most obvious differentiating feature is the presence of two separate pairs of differential inputs compared to a conventional op amp's single pair. Typically for the active-feedback architecture, one of these input pairs is driven by a differential input signal, while the other is used for the feedback. This active stage in the feedback path is where the term "active feedback" is derived.

The active feedback architecture offers several advantages over a conventional op amp in several types of applications. Among these are excellent common-mode rejection, wide input common-mode range and a pair of inputs that are high-impedance and totally balanced in a typical application. In addition, while an external feedback network establishes the gain response as in a conventional op amp, its separate path makes it totally independent of the signal input. This eliminates any interaction between the feedback and input circuits, which traditionally causes problems with CMRR in conventional differential-input op amp circuits.

Another advantage is the ability to change the polarity of the gain merely by switching the differential inputs. A high input-impedance inverting amplifier can be made. Besides a high input impedance, a unity-gain inverter with the AD8130 will have a noise gain of unity. This will produce lower output noise and higher bandwidth than op amps that have noise gain equal to 2 for a unity gain inverter.

The two differential input stages of the AD8129/AD8130 are each transconductance stages that are well matched. These stages convert the respective differential input voltages to internal currents. The currents are then summed and converted to a voltage, which is buffered to drive the output. The compensation capacitor is in the summing circuit.

When the feedback path is closed around the part, the output will drive the feedback input to that voltage which causes the internal currents to sum to zero. This occurs when the two differential inputs are equal and opposite; that is, their algebraic sum is zero.

In a closed-loop application, a conventional op amp will have its differential input voltage driven to near zero under nontransient conditions. The AD8129/AD8130 generally will have differential input voltages at each of its input pairs, even under equilibrium conditions. As a practical consideration, it is necessary to internally limit the differential input voltage with a clamp circuit.

Thus, the input dynamic ranges are limited to about 2.5 V for the AD8130 and 0.5 V for the AD8129 (see Specification section for more detail). For this and other reasons, it is not recommended to reverse the input and feedback stages of the AD8129/AD8130, even though some apparently normal functionality might be observed under some conditions.

A few simple circuits can illustrate how the active feedback architecture of the AD8129/AD8130 operates.

## Op Amp Configuration

If only one of the input stages of the AD8129/AD8130 is used, it will function very much like a conventional op amp. (See Figure 4.) Classical inverting and noninverting op amps circuits can be created, and the basic governing equations will be the same as for a conventional op amp. The unused input pins form the second input and should be shorted together and tied to ground or some midsupply voltage when they are not used.

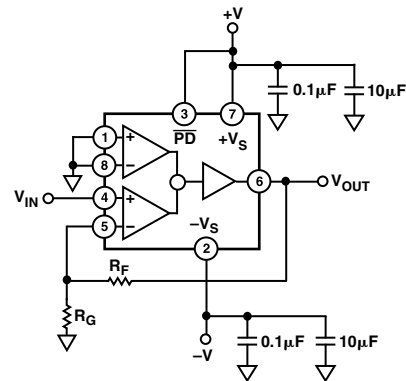

Figure 4. With both inputs grounded, the feedback stage functions like an op amp:  $V_{OUT} = V_{IN} (1 + R_F/R_G)$ . NOTE: This circuit is provided to demonstrate device operation. It is not suggested to use this circuit in place of an op amp.

With the unused pair of inputs shorted, there is no differential voltage between them. This dictates that the differential input voltage of the used inputs will also be zero for closed-loop applications. Since this is the governing principle of conventional op amp circuits, an active feedback amplifier can function as a conventional op amp under these conditions.

Note that this circuit is presented only for illustration purposes, to show the similarities of the active feedback architecture functionality to conventional op amp functionality. If it is desired to design a circuit that can be created from a conventional op amp, it is recommended to choose a conventional op amp whose specifications are better suited to that application. These op amp principles are the basis for offsetting the output as described in the Output Offset/Level Translator section.

## APPLICATIONS

### Basic Gain Circuits

The gain of the AD8129/AD8130 can be set with a pair of feedback resistors. The basic configuration is shown in Figure 5. The gain equation is the same as that of a conventional op amp:  $G = 1 + R_F/R_G$ . For unity gain applications using the AD8130,  $R_F$  can be set to zero (short circuit), and  $R_G$  can be removed. (See Figure 6.) The AD8129 is compensated to operate at gains of 10 and higher, so shorting the feedback path to obtain unity gain will cause oscillation.

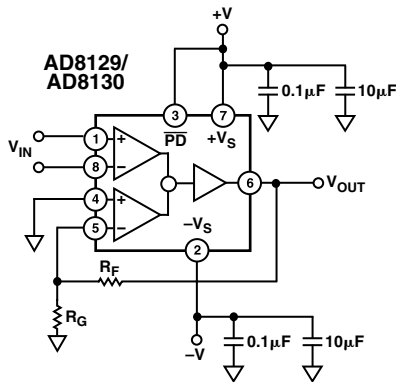

Figure 5. Basic Gain Circuit:  $V_{OUT} = V_{IN} (1 + R_F/R_G)$

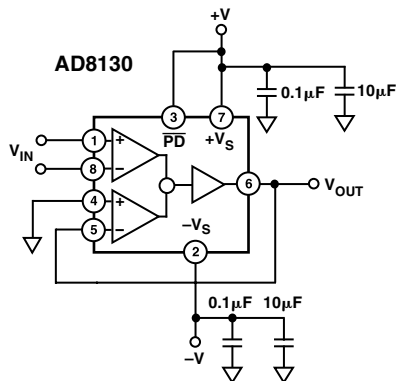

Figure 6. An AD8130 with Unity Gain

The input signal can be applied either differentially or single-endedly—all that matters is the magnitude of the differential signal between the two inputs. For single-ended input applications, applying the signal to the +IN with -IN grounded will create a noninverting gain, while reversing these connections will create an inverting gain. Since the two inputs are high-impedance and matched, both of these conditions will provide the same high input impedance. Thus, an advantage of the active feedback architecture is the ability to make a high-input-impedance, inverting op amp. If conventional op amps are used, a high impedance buffer followed by an inverting stage is needed. This requires two op amps.

### Twisted-Pair Cable, Composite Video Receiver with Equalization Using an AD8130

The AD8130 has excellent common-mode rejection at its inputs. This makes it an ideal candidate for a receiver for signals that are transmitted over long distances on twisted-pair cables. Category 5 type cables are now very common in office settings and are extensively used for data transmission. These same cables can also be used for the analog transmission of signals like video.

These long cables will pick up noise from the environment they pass through. This noise will not favor one conductor over another, and will therefore be a common-mode signal. A receiver that rejects the common-mode signal on the cable can greatly enhance the signal-to-noise ratio performance of the link.

The AD8130 is also very easy to use as a differential receiver, because the differential inputs and the feedback inputs are entirely separate. This means that there is no interaction of the feedback network and the termination network as there would be in conventional op amp-type receivers.

Another issue to be dealt with on long cables is the attenuation of the signal at longer distances. This attenuation is a function of frequency and increases as roughly as the square root of frequency.

For good fidelity of video circuits, the overall frequency response of the transmission channel should be flat versus frequency. Since the cable attenuates the high frequencies, a frequency-selective boost circuit can be used to undo this effect. These circuits are called equalizers.

An equalizer uses frequency-dependent elements (Ls and Cs) in order to create a frequency response that is the opposite of the rest of the channel's response in order to create an overall flat response. There are many ways to create such circuits, but a common technique is to put the frequency-selective elements in the feedback path of an op amp circuit. The AD8130 in particular makes this easier than other circuits, because, once again, the feedback path is totally independent of the input path and there is no interaction.

The circuit in Figure 7 was developed as a receiver/equalizer for transmitting composite video over 300 m of Category 5 cable. This cable has an attenuation of approximately 20 dB at 10 MHz for 300 m. At 100 MHz, the attenuation is approximately 60 dB. (See Figure 8.)

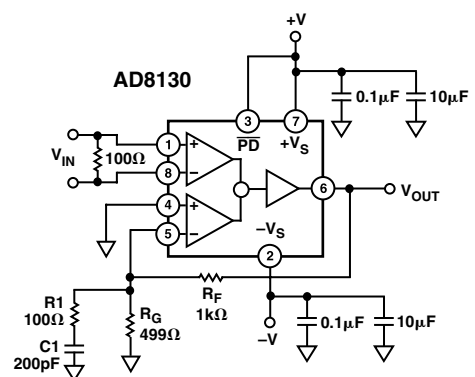

Figure 7. An Equalizer Circuit for Composite Video Transmission over 300 m of Category 5 Cable

# AD8129/AD8130

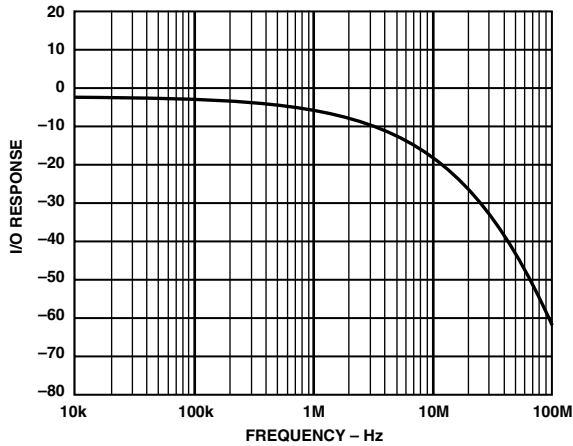

Figure 8. Transmission Response of 300 m of Category 5 Cable

The feedback network is between Pins 6 and 5 and from Pin 5 to ground. C1 and R<sub>F</sub> create a corner frequency of about 800 kHz. The gain increases to provide about 15 dB of boost at 8 MHz. The response of this circuit is shown in Figure 9.

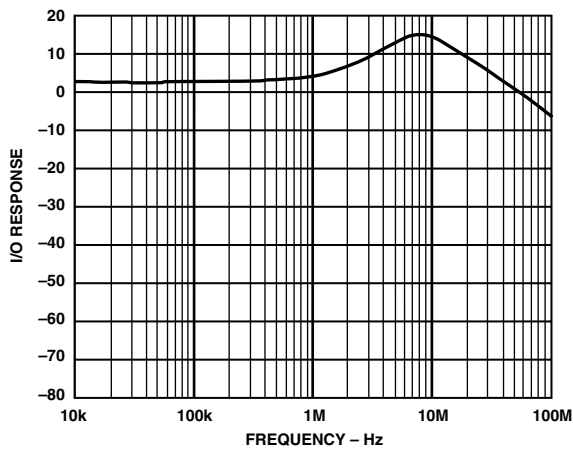

Figure 9. Frequency Response of Equalizer Circuit

It is difficult to come up with the exact component values via strictly mathematical means, because the equations for the cable attenuation are approximate and have functions that are not simply related to the responses of RC networks. The method used in this design was to approximate the required response via graphical means from the frequency response, and then select components that would approximate this response. The circuit was then built and measured, and finally adjusted to obtain an acceptable response—in this case flat to 9 MHz to within approximately 1 dB. (See Figure 10.)

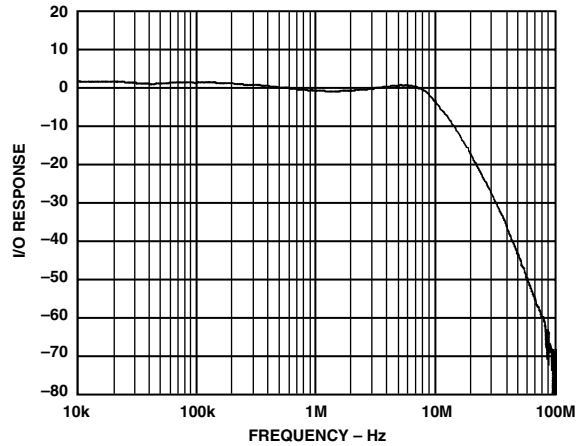

Figure 10. Combined Response of Cable Plus Equalizer

## Output Offset/Level Translator

The circuit in Figure 6 has the reference input (Pin 4) tied to ground, which produces a ground-referenced output signal. If it is desired to offset the output voltage from ground, the REF input can be used. (See Figure 11). The level V<sub>OFFSET</sub> appears at the output with unity gain.

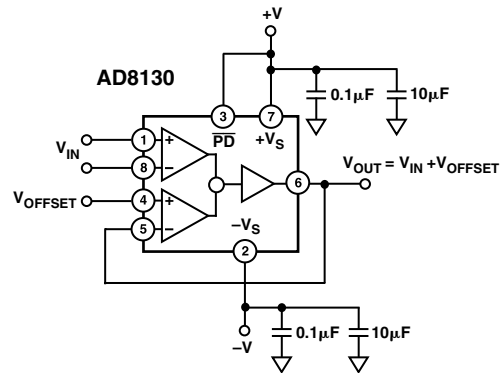

Figure 11. The voltage applied to Pin 4 adds to the unity-gain output voltage produced by V<sub>IN</sub>.

If the circuit has a gain higher than unity, the gain has to be factored in. If R<sub>G</sub> is connected to ground, the voltage applied to REF will be multiplied by the gain of the circuit and appear at the output; just like a noninverting conventional op amp, This situation is not always desirable and one may want V<sub>OFFSET</sub> to appear at the output with unity gain.

One way to accomplish this is to drive both REF and R<sub>G</sub> with the desired offset signal. (See Figure 12.) Superposition can be used to solve this circuit. First break the connection between V<sub>OFFSET</sub> and R<sub>G</sub>. With R<sub>G</sub> grounded the gain from Pin 4 to V<sub>OUT</sub> will be 1 + R<sub>F</sub>/R<sub>G</sub>. With Pin 4 grounded, the gain through R<sub>G</sub> to V<sub>OUT</sub> is -R<sub>F</sub>/R<sub>G</sub>. The sum of these is +1. If V<sub>REF</sub> is delivered from a low-impedance source, this will work fine. However, if the delivered offset voltage is derived from a high-impedance source, like a voltage divider, its impedance will affect the gain equation. This makes the circuit more complicated as it creates an interaction between the gain and offset voltage.

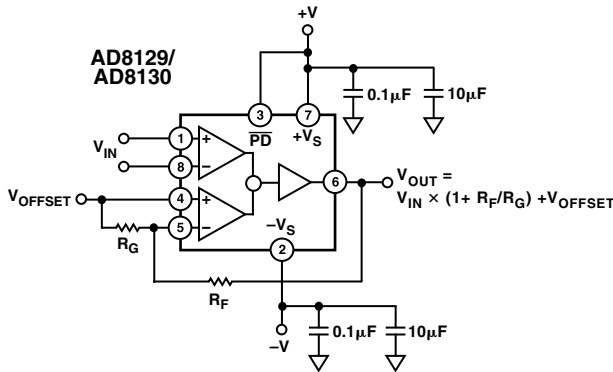

Figure 12. In this circuit,  $V_{\text{OFFSET}}$  appears at the output with unity gain. This circuit works well if the  $V_{\text{OFFSET}}$  Source Impedance is low.

A way around this is to apply the offset voltage to a voltage divider whose attenuation factor matches the gain of the amplifier, and then apply this voltage to the high-impedance REF input. This circuit will first divide the desired offset voltage by the gain, and the amplifier will multiply it back up to unity. (See Figure 13.)

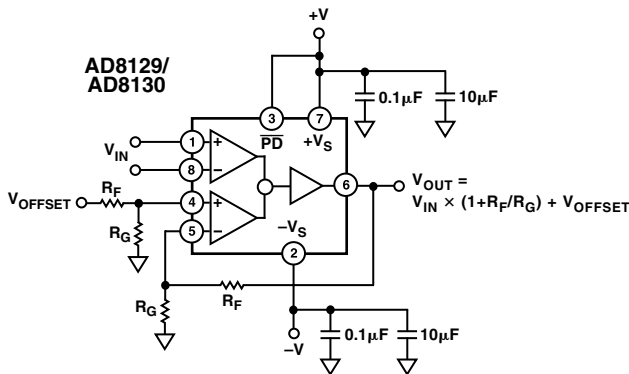

Figure 13. Adding an attenuator at the offset input causes it to appear at the output with unity gain.

### Resistorless Gain-of-Two

The voltage applied to the REF input (Pin 4) can also be a high bandwidth signal. If a unity-gain AD8130 has both +IN and REF driven with the same signal, there will be unity gain from  $V_{\text{IN}}$  and unity gain from  $V_{\text{REF}}$ . Thus, the circuit will have a gain of two, and requires no resistors. (See Figure 14.)

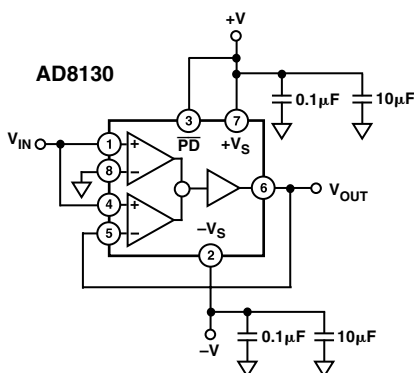

Figure 14. Gain-of-Two Connections with No Resistors

### Summer

A general summing circuit can be made by the above technique. A unity-gain configured AD8130 has one signal applied to +IN, while the other signal is applied to REF. The output will be the sum of the two input signals. (See Figure 15.)

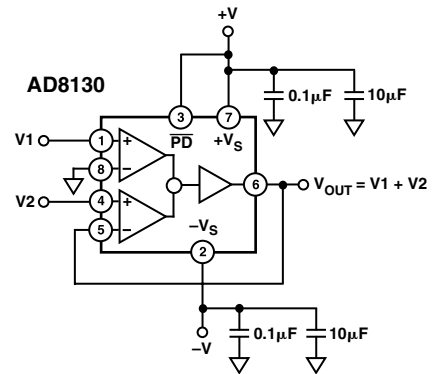

Figure 15. A Summing Circuit that is Noninverting with High Input Impedance

This circuit offers several advantages over a conventional op amp inverting summing circuit. First, the inputs are both high-impedance and the circuit is noninverting. It would require significant additional circuitry to make an op amp summing circuit that has high input impedance and is noninverting.

Another advantage is that the AD8130 circuit still preserves the full bandwidth of the part. In a conventional summing circuit, the noise gain is increased for every additional input, so the bandwidth response decreases accordingly. By this technique, four signals can be summed by applying them to two AD8130s, and then summing the two outputs by a third AD8130.

### Cable-Tap Amplifier

It is often desirable to have a video signal drive several different pieces of equipment. However, the cable should only be terminated once at its end point, so it is not appropriate to have a termination at each device. A “loop-through” connection allows a device to tap the video signal while not disturbing it by any excessive loading.

Such a connection, also referred to as a cable-tap amplifier, can be simply made with an AD8130. (See Figure 16.) The circuit is configured with unity gain, and if no output offset is desired, the REF pin is grounded. The negative differential input is connected directly to the shield of the cable (or an associated connector) at the point at which it wants to be “tapped.”

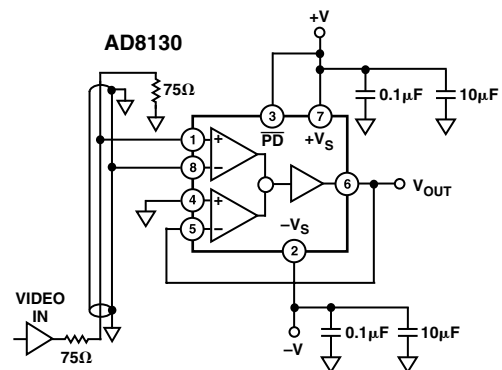

Figure 16. The AD8130 can tap the video signal at any point along the cable without loading the signal.

## AD8129/AD8130

The center conductor connects to the positive differential input of the AD8130. The amplitude of the video signal at this point is unity, because it is between the two termination resistors. The AD8130 provides a high impedance to this signal, so it does not disturb it. A buffered, unity-gain version of the video signal appears at the output.

### Power-Down

The AD8129/AD8130 have a power-down pin that can be used to lower the quiescent current when the amplifier is not being used. A logic low level on the PD pin will cause the part to power down.

Since there is no “Ground” pin on the AD8129/AD8130, there is no logic reference to interface to standard logic levels. For this reason, the reference level for the PD input is  $+V_S$ . If the AD8129/AD8130 are run with  $+V_S = 5\text{ V}$ , there will be direct compatibility with logic families. However, if  $+V_S$  is higher than this, a level-shift circuit will be needed to interface to conventional logic levels. A simple level-shifting circuit that is compatible with common logic families is presented in Figure 17.

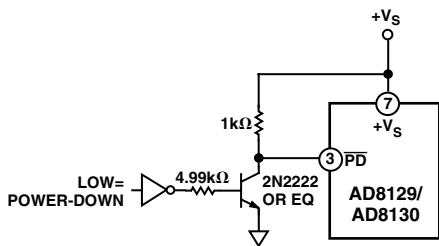

Figure 17. Circuit that Shifts the Logic Level when  $+V_S$  Is Not Equal to Approximately 5 V

### Extreme Operating Conditions

The AD8129/AD8130 are designed to provide high performance over a wide range of supply voltages. However, there are some extremes of operating conditions that have been observed to produce non-optimal results. One of these conditions occurs when the AD8130 is operated at unity gain with low supply voltage—less than approximately  $\pm 4\text{ V}$ .

At unity gain, the output drives FB directly. At supplies of  $\pm V_S$  less than approximately  $\pm 4\text{ V}$  and unity gain, the voltage on FB can be driven by the output too close to the rail for the circuit to stay properly biased. This can lead to a parasitic oscillation.

A way to prevent this is to limit the input signal swing with clamp diodes. Common silicon junction signal diodes like the 1N4148 have a forward bias of approximately 0.7 V when about 1 mA of current flow through them. Two series pairs of such diodes connected antiparallel across the differential inputs can be used to clamp the input signal and prevent this condition. It should be noted that the REF input can also shift the output signal, so this technique will only work when REF is at ground or close to it. (See Figure 18.)

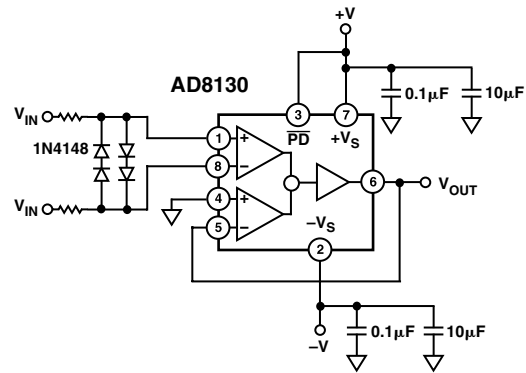

Figure 18. Clamping Diodes at the Input Limit the Input Swing Amplitude

Another problem can occur with the AD8129 operating at supply voltage of greater than or equal to  $\pm 12\text{ V}$ . The architecture causes the supply current to increase as the input differential voltage increases. If the AD8129 differential inputs are overdriven too far, excessive current can flow in the device and potentially cause permanent damage.

A practical means to prevent this from occurring is to differentially clamp the inputs with a pair of antiparallel Schottky diodes. (See Figure 19.) These diodes have a lower forward voltage of approximately 0.4 V. If the differential voltage across the inputs is restricted to these conditions, no excess current will be drawn by the AD8129 under these operating conditions.

If the supply voltage is restricted to less than  $\pm 11\text{ V}$ , the internal clamping circuit will limit the differential voltage and excessive supply current will not be drawn. The external clamp circuit is not needed.

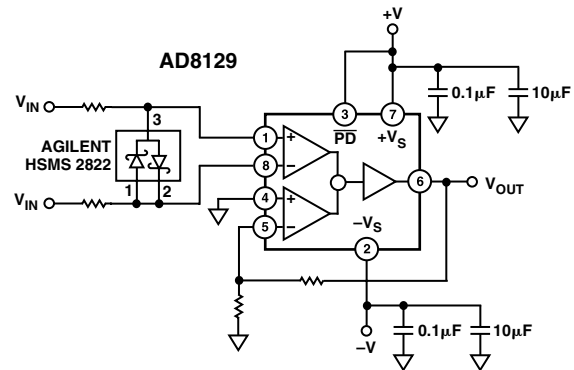

Figure 19. Schottky Diodes Across the Inputs Limits the Input Differential Voltage

In both circuits, the input series resistors to limit the current through the diodes when they are forward-biased. As a practical matter, these resistors need to be matched to the degree that the CMRR needs to be preserved at high frequency. These resistor will have minimal effect on the CMRR at low frequency.



**Power Dissipation**

The AD8129/AD8130 can operate with supply voltages from +5 V to  $\pm 12$  V. The major reason for such a wide supply range is to provide a wide input common-mode range for systems that might require this. This would be encountered when significant common-mode noise couples into the input path. For applications that do not require a wide input or output dynamic range, it is recommended to operate with lower supply voltages.

The AD8129/AD8130 is also available in a very small Micro\_SO-8 package. This has higher thermal impedance than larger packages and will operate at a higher temperature with the same amount of power dissipation. Certain operating conditions that are within the specification range of the parts can cause excess power dissipation. Caution should be exercised.

The power dissipation is a function of several operating conditions. These include the supply voltage, the input differential voltage, the output load and the signal frequency.

A basic starting point is to calculate the quiescent power dissipation with no signal and no differential input voltage. This is just the product of the total supply voltage and the quiescent operating current. The maximum operating supply voltage is 26.4 V and the quiescent current is 13 mA. This causes a quiescent power dissipation of 343 mW. For the Micro\_SO package, the  $\theta_{JA}$  specification is 142°C/W. So the quiescent power will cause about a 49°C rise above ambient in the Micro\_SO package.

The current consumption is also a function of the differential input voltage. (See TPCs 109 and 110.) This current should be added on to the quiescent current and then multiplied by the total supply voltage to calculate the power.

The AD8129/AD8130 can directly drive loads of as low as 100  $\Omega$ , such as a terminated 50  $\Omega$  cable. The worst-case power dissipation in the output stage occurs when the output is at midsupply. As an example, for a 12 V supply and the output driving a 250  $\Omega$  load to ground, the maximum power dissipation in the output will occur when the output voltage is 6 V.

The load current will be  $6 \text{ V}/250 \Omega = 24 \text{ mA}$ . This same current will flow through the output across a 6 V drop from +V<sub>S</sub>. This will dissipate 144 mW. For the Micro\_SO-8 package, this causes a temperature rise of 20°C above ambient. Although this is a worst-case number, it is apparent that this can be a considerable additional amount of power dissipation.

Several changes can be made to alleviate this. One is to use the standard SO-8 package. This will lower the thermal impedance to 121°C/W, which is a 15% improvement. Next is to use a lower supply voltage unless absolutely necessary.

Finally, do not use the AD8129/AD8130 to directly drive a heavy load when it is operating on high supply voltages. It is best to use a second op amp after the output stage. Some of the gain can be shifted to this stage so that the signal swing at the output of the AD8129/AD8130 is not too large.

**Layout, Grounding and Bypassing**

The AD8129/AD8130 are very high-speed parts that can be sensitive to the PCB environment in which they have to operate. Realizing their superior specifications requires attention to various details of standard high-speed PCB design practice.

The first requirement is for a good solid ground plane that covers as much of the board area around the AD8129/AD8130 as possible. The only exception to this is that the ground plane around the FB pin should be kept a few mm away, and ground should be removed from inner layers and the opposite side of the board under this pin. This will minimize the stray capacitance on this node and help preserve the gain flatness versus frequency.

The power supply pins should be bypassed as close as possible to the device to the nearby ground plane. Good high-frequency ceramic chip capacitors should be used. This bypassing should be done with a capacitance value of 0.01  $\mu\text{F}$  to 0.1  $\mu\text{F}$  for each supply. Further away, low frequency bypassing should be provided with 10  $\mu\text{F}$  tantalum capacitors from each supply to ground.

The signal routing should be short and direct in order to avoid parasitic effects. Where possible, signals should be run over ground planes to avoid radiating, or to avoid being susceptible to other radiation sources.

# AD8129/AD8130

## OUTLINE DIMENSIONS

Dimensions shown in inches and (mm).

### 8-Lead SOIC (SO-8)

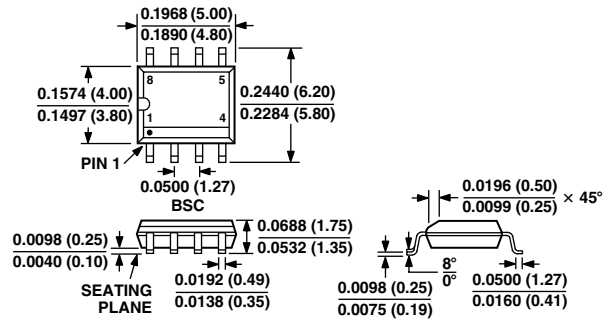

### 8-Lead Micro\_SO (RM-8)

